

SOUNDCOMM B40 HEADSET

Please read and keep all safety and use instructions.

Important Safety Instructions

1. Read these instructions.
2. Keep these instructions.
3. Heed all warnings.
4. Follow all instructions.
5. Do not use this apparatus near water.
6. Clean only with a dry cloth.
7. Only use attachments/accessories specified by the manufacturer.
8. Refer all servicing to qualified personnel. Servicing is required when the apparatus has been damaged in any way, such as power-supply cord or plug is damaged, liquid has been spilled or objects have fallen into the apparatus, the apparatus has been exposed to rain or moisture, does not operate normally, or has been dropped.

WARNING/CAUTION

- Do NOT use the headset at a high volume for any extended period.
 - To avoid hearing damage, use your headset at a comfortable, moderate volume level.
 - Turn the volume down on your device before placing the headset on your ears, then turn the volume up gradually until you reach a comfortable listening level.
 - Focus on your safety and that of others if you use th headset while engaging in any activity requiring your attention, e.g., while riding a bicycle or walking in or near traffic, a construction site or railroad, etc. Remove the headset or adjust your volume to ensure you can hear surrounding sounds, including alarms and warning signals.
- Do NOT use your headset while driving or at any time the inability to hear surrounding sounds may present a danger to yourself or others.
- Remove the headset immediately if you experience a warming sensation or loss of audio.
- Do NOT use the headset as an aviation communication headset.
- Do NOT use the headset if they emit any loud unusual noise. If this happens, turn the headset off and contact Bose customer service.
- Do NOT use mobile phone adapters to connect the headset to airplane seat jacks, as this could result in injury or property damage due to overheating.



Contains small parts which may be a choking hazard. Not suitable for children under age 3.



This product contains magnetic material. Consult your physician on whether this might affect your implantable medical device.

- Do NOT expose this product to dripping or splashing, and do not place objects filled with liquids, such as vases, on or near the product.
- Keep the product away from fire and heat sources. Do NOT place naked flame sources, such as lighted candles, on or near the product.
- Do not expose products containing batteries to excessive heat (e.g. from storage in direct sunlight, fire or the like).
- Do NOT make unauthorized alterations to this product.

NOTE: This equipment has been tested and found to comply with the limits for a Class B digital device, pursuant to Part 15 of the FCC Rules. These limits are designed to provide reasonable protection against harmful interference in a residential installation. This equipment generates, uses, and can radiate radio frequency energy and, if not installed and used in accordance with the instructions, may cause harmful interference to radio communications. However, there is no guarantee that interference will not occur in a particular installation. If this equipment does cause harmful interference to radio or television reception, which can be determined by turning the equipment off and on, the user is encouraged to try to correct the interference by one or more of the following measures:

- Reorient or relocate the receiving antenna.
- Increase the separation between the equipment and receiver.
- Connect the equipment into an outlet on a circuit different from that to which the receiver is connected.
- Consult the dealer or an experienced radio/TV technician for help.

Changes or modifications not expressly approved by Bose Corporation could void the user's authority to operate this equipment.

This device complies with part 15 of the FCC Rules and with Industry Canada license-exempt RSS standard(s). Operation is subject to the following two conditions: (1) This device may not cause harmful interference, and (2) this device must accept any interference received, including interference that may cause undesired operation.



This product conforms to all applicable EU directive requirements. The complete declaration of conformity can be found at: www.Bose.com/compliance



This symbol means the product must not be discarded as household waste, and should be delivered to an appropriate collection facility for recycling. Proper disposal and recycling helps protect natural resources, human health and the environment. For more information on disposal and recycling of this product, contact your local municipality, disposal service, or the shop where you bought this product.

Please complete and retain for your records

The serial and model numbers are located beneath the left side of the headband.

Serial number: _____

Model number: _____

Please keep your receipt with your owner's guide. Now is a good time to register your Bose product. You can easily do this by going to <http://global.Bose.com/register>

Date of Manufacture: The eighth digit in the serial number indicates the year of manufacture; "8" is 2008 or 2018.

EU Importer: Bose Products B.V., Gorslaan 60, 1441 RG Purmerend, The Netherlands

©2018 Bose Corporation. No part of this work may be reproduced, modified, distributed or otherwise used without prior written permission.

WHAT'S IN THE CARTON

Contents	6
----------------	---

HEADSET COMPONENTS

Headset.....	7
--------------	---

HOW TO WEAR THE HEADSET

Fit the headset.....	8
Adjust the headset fit.....	8

MICROPHONE

Adjust the microphone.....	9
Move the microphone assembly (dual headset only)	10

HOW TO WEAR THE CONTROL MODULE (OPTIONAL)

Use the belt clip.....	12
Disconnect the belt clip	12
Use the belt pack bracket	13
Attach the bracket to your radio/belt pack.....	13
Attach the control module to your radio/belt pack.....	14
Connect the control module	14
Disconnect the control module.....	15

ACOUSTIC NOISE CANCELLATION

Power on	16
Power off.....	16

BATTERIES

Install the batteries..... 17
 Battery life 17

HEADSET STATUS

Battery Status 18

CARE AND MAINTENANCE

Store the headset 19
Clean the headset..... 20
Replacement parts and accessories..... 21
 Replacement Instructions..... 21

TECHNICAL INFORMATION

Serial number location..... 23
Limited warranty 23
Headset Specification 24
Microphone Specifications 24
On head Weight 25
Cable length 25
Headset variants..... 25

TROUBLESHOOTING

Try these solutions first 26
Other solutions 26

CONTENTS

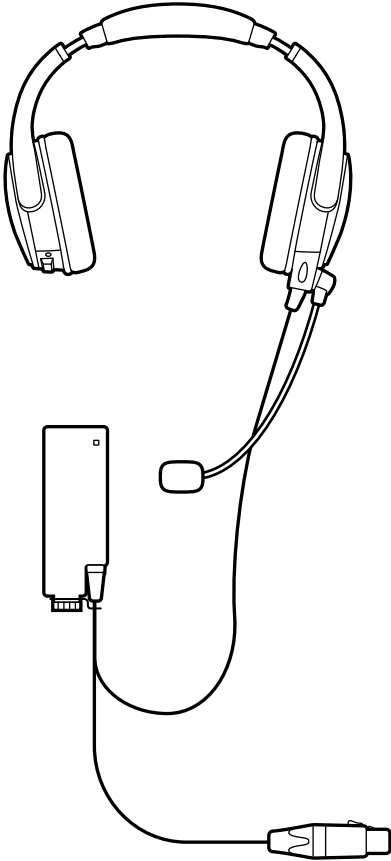

Bose SoundComm B40 Headset
(single earcup or dual earcup)



Carry case

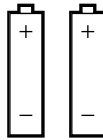

AA batteries (2)

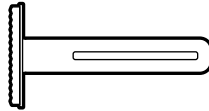

Belt pack bracket

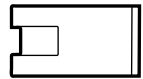

Belt clip

NOTE: If any part of the product is damaged, don't use it. Contact your authorized Bose dealer or Bose customer service.

Visit: worldwide.Bose.com/Support/B40

HEADSET

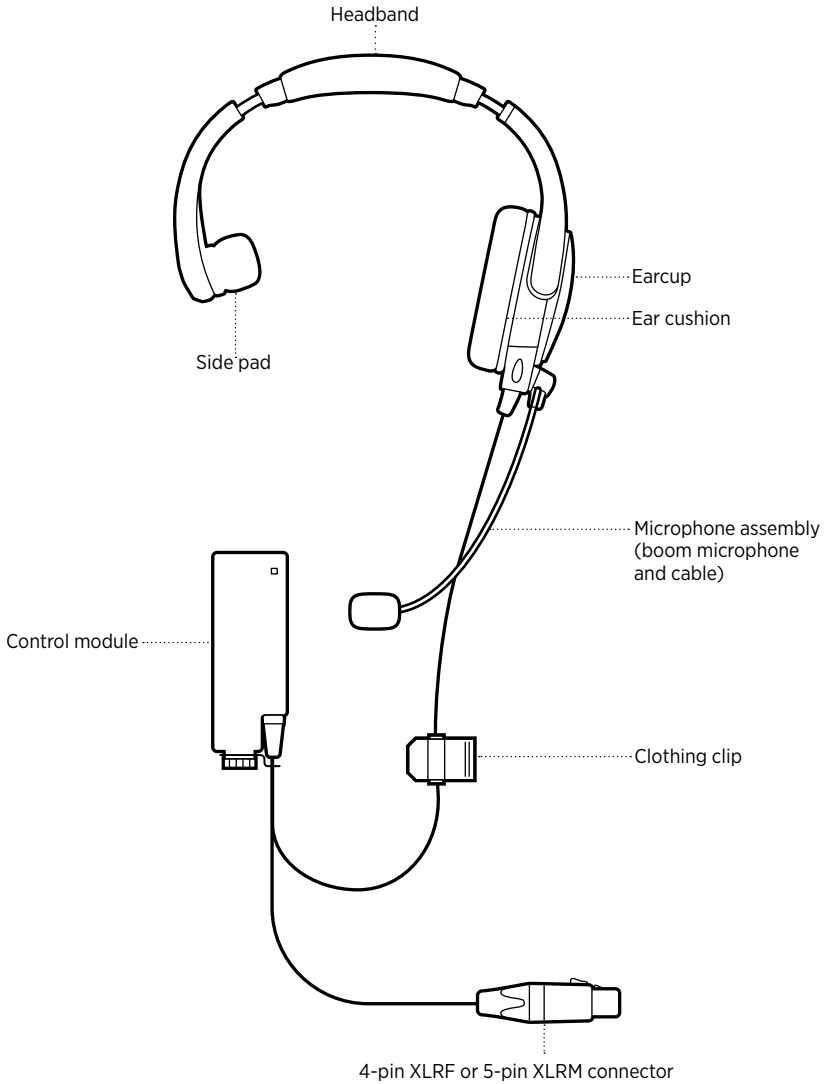

NOTES: Left earcup model pictured.
Dual earcup headset pictured on page 6.

FIT THE HEADSET

As you put the headset on, adjust each earcup so its cushion is completely over your ear. You should feel an even, gentle pressure all around each ear.

NOTE: Make sure you wear the headset in the correct orientation. Inside of each earcup (scrim) is clearly marked with an **L** (left) or an **R** (right).



Adjust the headset fit

If you need to adjust the headband, make sure the headband is evenly centered on top of your head. The headband should rest gently on your head.

NOTE: For best comfort, make your final adjustments with noise cancellation powered on in a noisy environment.

ADJUST THE MICROPHONE

Microphone placement is important for clear communications.

NOTE: On the dual headset, the microphone assembly comes attached to the left earcup. To move the microphone to the other earcup, see page 10.

1. Grasp the microphone with your fingers and adjust so it is level with your mouth.
2. Position the microphone so it is 0.25" (6.35 mm) from your lips.

NOTE: The microphone should not be touching your lips.

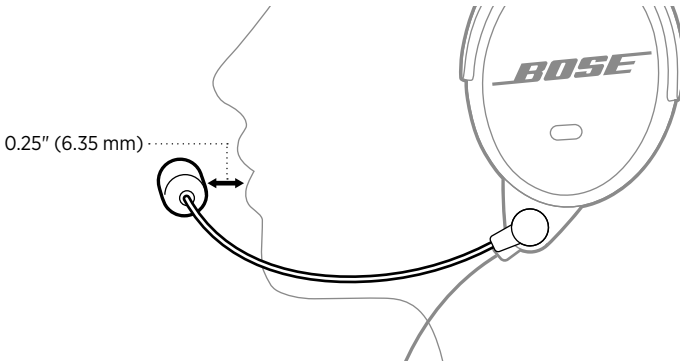

CAUTION: The microphone can rotate up to 320°. Do NOT force the microphone beyond the intended rotation or damage could occur.

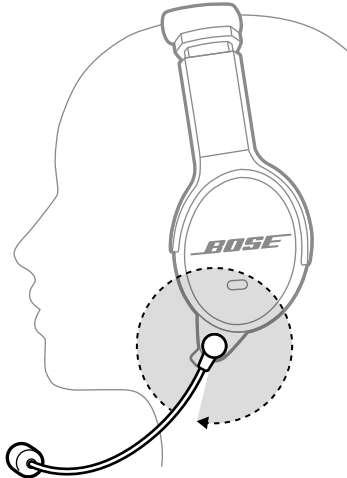

MOVE THE MICROPHONE ASSEMBLY (DUAL HEADSET ONLY)

The dual earcup headset has a reversible microphone assembly that can be worn on the left or right side of the headset.

1. Using a Phillips screwdriver (not provided), loosen the two screws on the microphone assembly base on the bottom of the earcup.

NOTE: Rotate the microphone up towards the headband for additional space to loosen the screws.

2. Pull the microphone assembly down to remove from the earcup.

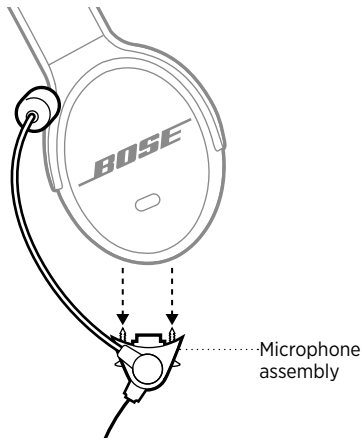

3. On the other earcup, loosen the two screws on the terminator cover.
4. Pull the terminator cover down to remove from the earcup.

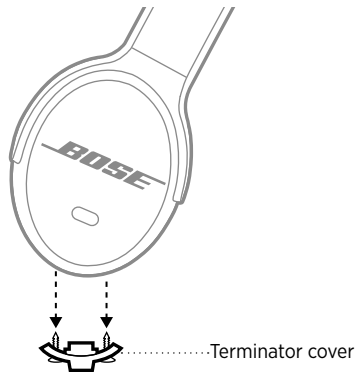

- Align and attach the microphone assembly to the connectors on the preferred earcup.

CAUTION: Do NOT force the connectors or the earcup may be damaged.

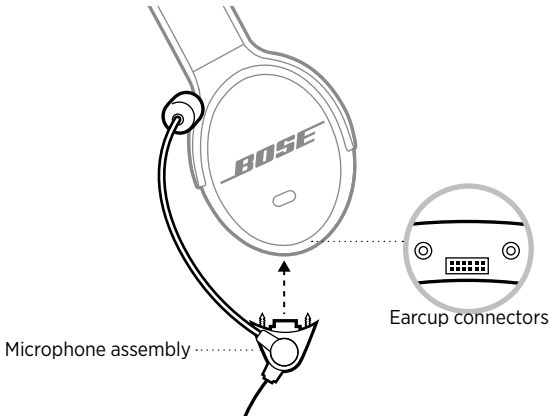

- On the microphone assembly base, tighten the two screws until the assembly is secure to the headset.
- Align and attach the terminator cover to the other earcup.

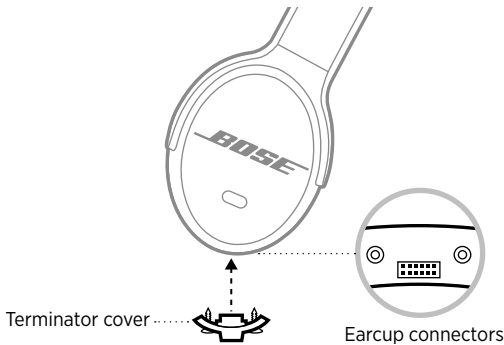

- On the terminator cover, tighten the screws until the cover is secure to the headset.

NOTE: In order to use the headset, the terminator cover must be securely attached to the headset.

USE THE BELT CLIP

1. Align the dual lock tab on the belt clip to the dual lock tab on the control module.

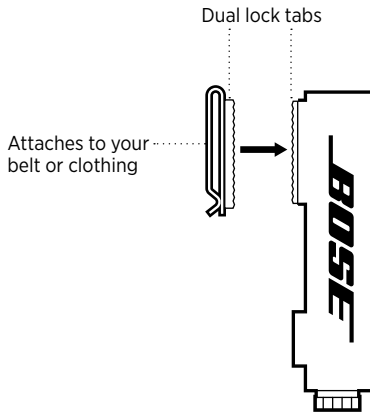

2. Press firmly to attach.

Disconnect the belt clip

Starting from the top, pull the belt clip away from the control module.

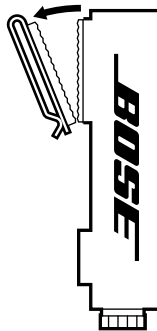

USE THE BELT PACK BRACKET

Attach the bracket to your radio/belt pack

1. On the back of your radio/belt pack, loosen the two screws and remove the belt clip.

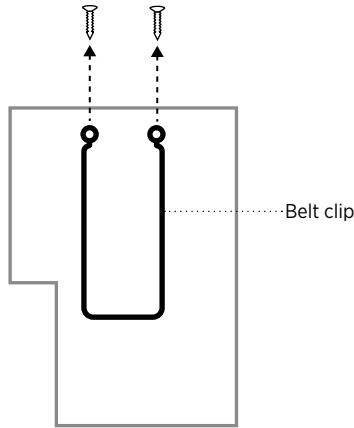

2. Aligning the screw holes, place the bracket on top of your radio/belt pack.

NOTE: The belt pack bracket can be attached to the left or right side of your radio/belt pack.

3. Aligning the screw holes, place the belt clip on top of the bracket.

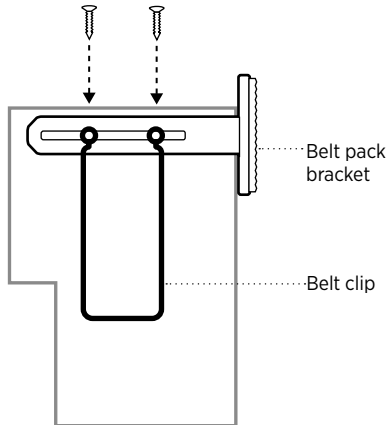

4. Re-insert the two screws from your radio/belt pack and tighten until secure.

ATTACH THE CONTROL MODULE TO YOUR RADIO/BELT PACK

1. Align the dual lock tab on the control module with the dual lock tab on the belt pack bracket.

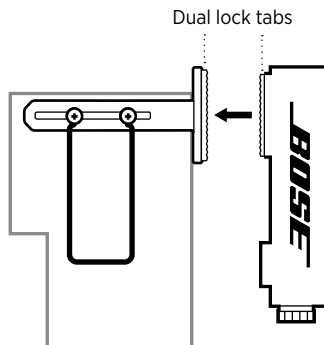

2. Press firmly until you hear a click.

CONNECT THE CONTROL MODULE

1. Align the XLR connector with the pins on your radio/belt pack connector.

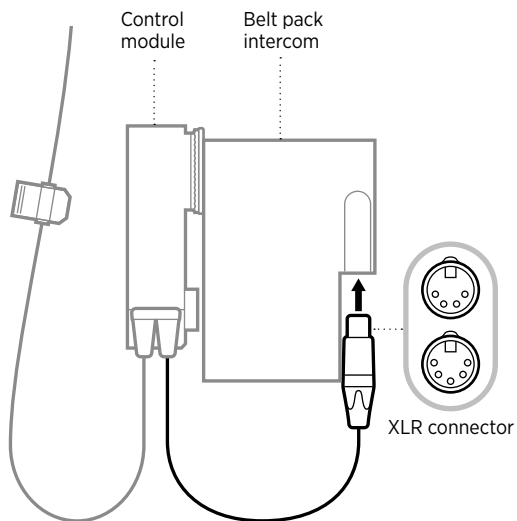

2. Press firmly until you hear a click.

NOTE: The headset can also connect to a camera using the XLR connector. Refer to your camera owner's guide for connection instructions.

DISCONNECT THE CONTROL MODULE

1. On the XLR connector, press down on the metal tab and gently pull the cable away from the belt pack.

NOTE: Most belt packs have a locking mechanism.

2. Starting at the bottom, pull the control module away from the dual lock tab on the belt pack.

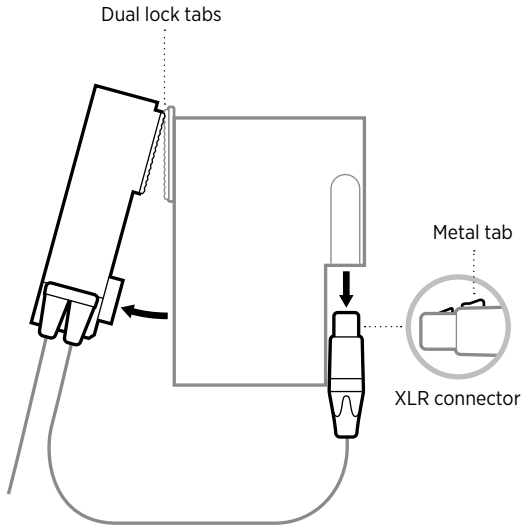

POWER ON

On the top of the control module, push the Power switch away from the battery light.

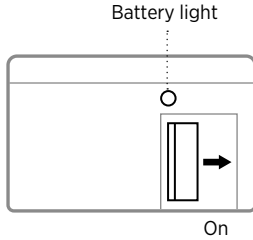

The battery light glows red for three seconds then shows the battery status (see page 18).

POWER OFF

On the top of the control module, push the Power switch towards the battery light.

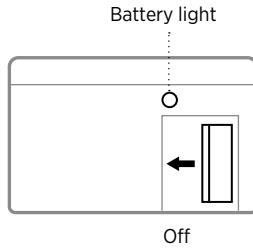

NOTE: When acoustic noise cancellation is off, the headset still provides audio and communications. To conserve battery, power off noise cancellation when the headset is not in use.

INSTALL THE BATTERIES

1. On the top of the control module, twist the cap to the left (counter-clockwise) to open the battery compartment.

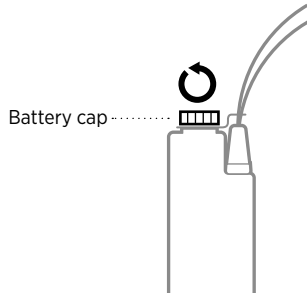

2. Insert the two AA alkaline batteries into the battery compartment. Match the + and - symbols on the batteries with the + and - markings on the control module.
3. Twist the cap to the right (clockwise) until secure.

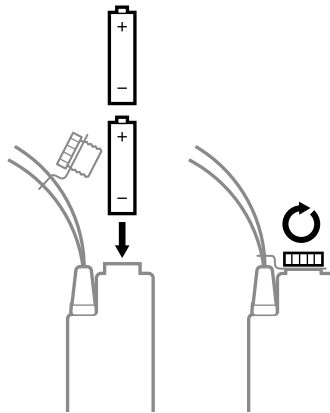

CAUTION: Only use AA alkaline batteries.

Battery life

Single earcup: up to 56 hours

Dual earcup: up to 48 hours

NOTE: For more information about battery status, see page 24.

BATTERY STATUS

The Battery light is located on the top of the control module, next to the Power switch.

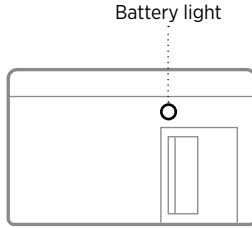

LIGHT ACTIVITY	BATTERY STATUS
Blinking green	Full charge
Blinking red (slow)	Medium charge (10 hours or less remaining)
Blinking red (fast)	Low charge (2.5 hours or less remaining)

STORE THE HEADSET

The headset should be stored in the supplied carry case.

1. Rotate the microphone assembly up, so the microphone gently rests next to the headband.
2. Place the headset in the case with the cable laying across the center hinge of the case.

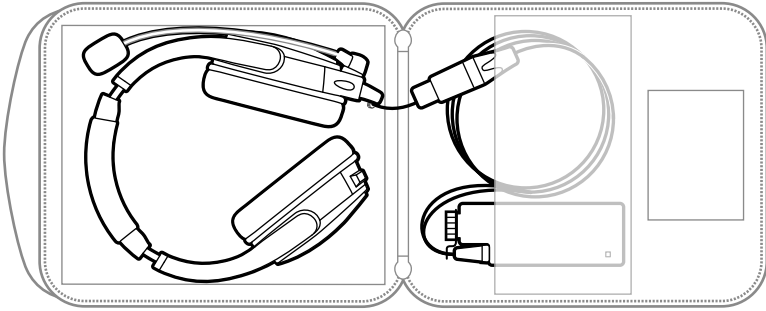

NOTE: When storing the headset for an extended period, remove the batteries.

CLEAN THE HEADSET

The headset may require periodic cleaning.

WARNING: Do NOT attempt to disassemble or clean the inside of the earcups or other parts of the headset. Only the microphone windscreen, side pad (single earcup), batteries, and ear cushions are replaceable by the user.

COMPONENT	CLEANING PROCEDURE
Headset/earcups	<ul style="list-style-type: none"> • Wipe the outside surfaces with a soft, dry cloth. • Carefully use tweezers, if necessary, to remove foreign matter that may be in the openings. • Do NOT to force any dirt or debris into the openings. • Do NOT blow air into or vacuum the openings as this may damage the headset. • Do NOT allow moisture to get inside the earcups or the audio input connector.
Ear cushions	<p>To extend the life of the ear cushions, perform regular cleaning.</p> <ul style="list-style-type: none"> • Remove the ear cushions (see page 21) and allow them to air dry. • Using a dry cloth, clean the flange surface located underneath the ear cushions of any debris. • Do NOT immerse the ear cushions in water or any other liquid.
Earcup inner screens (scrim)	<ul style="list-style-type: none"> • Air dry the earcup inner screen (scrim) if it becomes damp from environmental moisture such as light rain, dew, perspiration, or condensation. • Do NOT use electric heaters or blowers to dry the earcup inner screen. • Do NOT attempt to remove, replace, repair, or clean this component. If the screen appears damaged or worn out, contact Bose customer service.
Microphone windscreen	<p>Wipe the windscreen using a damp cloth and mild soap.</p>

REPLACEMENT PARTS AND ACCESSORIES

Replacement parts and accessories can be ordered through Bose customer service.

Visit: worldwide.bose.com/Support/B40

WARNING: Do NOT attempt to disassemble or service the inside of the earcups or other parts of the headset.

Replacement Instructions

Only the side pad (single earcup), microphone windscreen, batteries, and ear cushions are replaceable by the user.

Side pad (single earcup)

The side pad is attached to the headband with a dual lock tab.

1. Gently pull the old side pad away from the headband.
2. Align the new side pad with the dual lock tab and firmly press until secure.

Microphone windscreen

The microphone windscreen can be removed and replaced.

1. Carefully slide the windscreen off of the microphone.
2. Slide the replacement windscreen on and make sure it fits completely over the microphone.

Ear cushion

Ear cushions should be replaced every 3 – 6 months. Replace the ear cushions if you see:

- Flaking of the outer covering
- Cuts or tears
- Flattening of the cushion

You may have to replace the ear cushions more often if you:

- Have a full beard or thick facial hair
- Use the headset in extreme temperatures
- Damage the cushions because of improper storage

NOTE: Replacement instructions are also provided with the ear cushion replacement kit.

1. Gently pull the ear cushion up and away from the earcup.

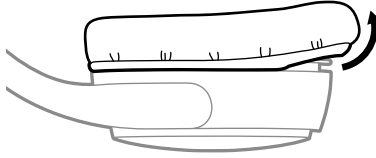

2. Remove the two adhesive strips from the earcup and clean the flange surface of any debris with a dry cloth.

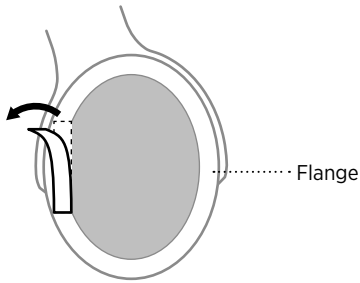

3. Align the new adhesive strips onto the left and right sides of the flange surface and press down.

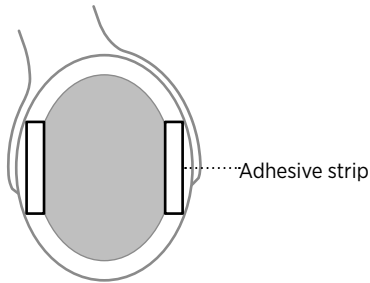

NOTE: Make sure you remove the paper backing from the adhesive strips.

4. Tuck the ear cushion skirt into the earcup groove and gently stretch the ear cushion around the earcup.

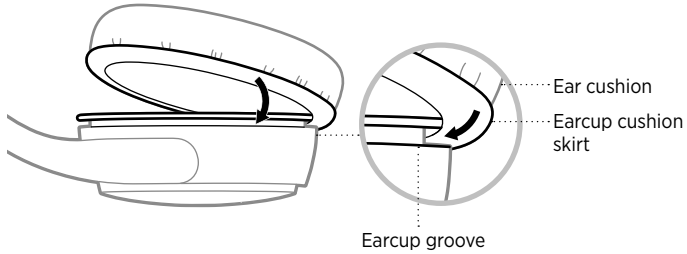

5. Press the ear cushion down over the two adhesive strips.

SERIAL NUMBER LOCATION

To locate the serial number, extend the left side of the headband to its largest size. The serial number is located beneath the left side of the headband.

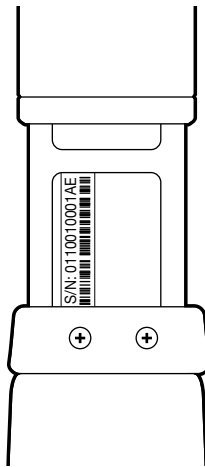

LIMITED WARRANTY

The headset is covered by a limited warranty. Visit our website at global.Bose.com/warranty for details of the limited warranty.

To register your product, visit global.Bose.com/register for instructions. Failure to register will not affect your limited warranty rights.

HEADSET SPECIFICATION

HEADSET VARIANT	INPUT IMPEDANCE	HEADSET SENSITIVITY @1mW @1kHz	ABSOLUTE MAX POWER RATING*
Monaural 4-pin XLR (single earcup)	120 ohm ± 10%	107 ± 3db SPL	500 mW
Monaural 4-pin XLR (dual earcup)	80 ohm ± 10%	104 ± 3db SPL	1000 mW
Binaural 5-pin XLR (per earcup)	260 ohm ± 10%	107 ± 3db SPL	500 mW

*Absolute maximum ratings indicate limits beyond which damage to the device may occur.

MICROPHONE SPECIFICATIONS

150 ohm Dynamic Noise Canceling

Frequency Response is optimized for improved intelligibility in noisy environments

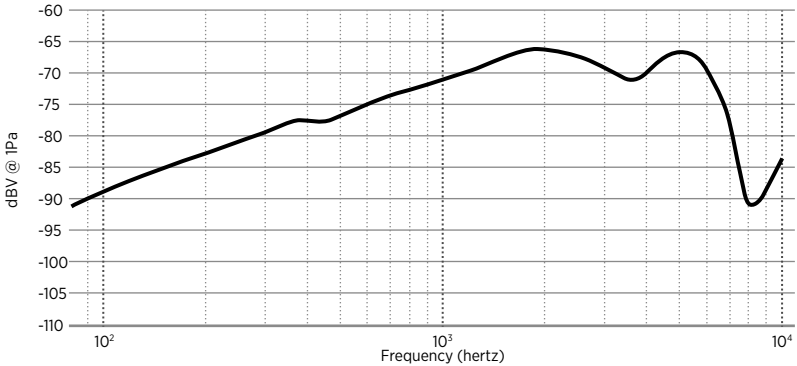

Microphone sensitivity: -71 dBV/Pa @ 1kHz*

*Open circuit signal level measured at the headset connector with no external load.

ON HEAD WEIGHT

Dual earcup: 12.7 oz.

Single earcup: 10 oz.

CABLE LENGTH

Headset to control module: 4 feet 10 inches

Control module to XLR connector: 10 inches

HEADSET VARIANTS

4-pin XLRF

Pin 1	Microphone Low
Pin 2	Microphone High
Pin 3	Headphone Low
Pin 4	Headphone High



5-pin XLRM

Pin 1	Microphone Low
Pin 2	Microphone High
Pin 3	Headphone_GND
Pin 4	Headphone_L
Pin 5	Headphone_R

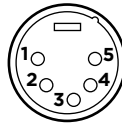

TRY THESE SOLUTIONS FIRST

If you experience problems with the headset, try these solutions first:

- Change the batteries in the control module (see page 17)
- Make sure the microphone assembly and terminator cover are secure (see page 10)
- Check that the connection to your radio/belt pack is secure.

WARNING: Do NOT use the headset if it emits a loud squeal or other loud noise. Contact Bose customer service if the headset emits any loud or unusual noise.

OTHER SOLUTIONS

If you could not resolve your issue, see the table below to identify symptoms and solutions to common problems. If you are unable to resolve your issue, contact Bose customer service.

Visit: worldwide.Bose.com/Support/B40

PROBLEM	WHAT TO DO
No audio/communications	<p>Check the volume setting on your radio/belt pack.</p> <p>Make sure the headset cable is securely connected to your radio/belt pack.</p> <p>Check the internal settings on your radio/belt pack.</p> <p>Try a different radio/belt pack.</p> <p>Try using the headset in a different seat location.</p> <p>Unplug all non-Bose headsets from the communications system to determine if there is an uneven load (wired intercom system only).</p>
No audio from one earcup (dual headset only)	<p>Make sure you are using the correct XLR connector configuration for your radio/belt pack.</p>
No noise cancellation	<p>Make sure noise cancellation is powered on (see page 16).</p> <p>Make sure the batteries are not drained and correctly installed (see page 17).</p> <p>Make sure the battery terminals are clean.</p> <p>Make sure the battery cap is secure.</p> <p>Check the batteries in your radio/belt pack.</p> <p>Try using the headset in a different seat location.</p> <p>Remove the microphone assembly and terminator cover to make sure there is no damage to the connectors or pins.</p>

PROBLEM	WHAT TO DO
Reduced noise cancellation, or unusual sounds	<p>Make sure there are no air gaps around the ear cushion seals.</p> <p>NOTE: If the ear cushions appear worn, they should be replaced (see page 21).</p>
Low volume of incoming communications	<p>Check the volume setting on your radio/belt pack.</p> <p>Unplug all other headsets and check if the volume level improves (for wired intercom system only).</p> <p>Try a different radio/belt pack.</p> <p>Move closer to the radio base station.</p> <p>NOTE: A typical wireless belt pack range is 30-50 yards.</p>
Squealing or whistling sound when noise cancellation is powered on	<p>Make sure you're wearing the headset in the correct orientation. Use the L (left) and R (right) markings inside the earcups for reference.</p> <p>Check that the seal between the ear cushion skirt and the earcup fit properly and there aren't any gaps. Replace any ear cushions that appear to be worn out.</p> <p>Adjust the headset fit so that your ears are completely inside the ear cushions. Make sure that a hat or eyeglasses do not interfere with the seal.</p> <p>Make sure the headset ear cushions, internal ear cup foams and scrims are dry. If not, air dry all parts and retry the headset. If the problem persists, contact Bose customer service.</p>
Low rumbling sound with the headset turned on in a quiet environment	<p>Check that the seal between the ear cushion skirt and the earcup fit properly and there aren't any gaps. Replace any ear cushions that appear to be worn out.</p>
Crackling sound audible with headset turned on in a loud environment, or noise reduction is intermittent	<p>Make sure the headset orientation is correct. Use the L (left) and R (right) markings inside the earcups to correctly orient the headset.</p> <p>Adjust the headset fit (see page 8).</p> <p>Replace the batteries in the control module.</p> <p>Check that the seal between the ear cushion skirt and the earcup fit properly and there aren't any gaps. Replace any ear cushions that appear to be worn out.</p> <p>Try a different radio/belt pack.</p> <p>Move closer to the radio base station.</p> <p>NOTE: A typical wireless belt pack range is 30-50 yards.</p>



026111-0010