



X SYSTEM[®]

COACHCOMM

OPERATING MANUAL



This page is intentionally blank.

Thank you from CoachComm!

We at CoachComm want to thank you for purchasing a CoachComm X-System Sideline Communications System. We have made every effort to build a reliable, intuitive communication system that provides the functionality that you can count on come game day.

One of our goals in the design of the CoachComm X-System was to build on the advances set forth by the previous Tempest® NG System and to provide users with unmatched RF performance. You will be able to begin using your new X-System with nothing more than the Game Day Guide. However, to fully benefit from the available features, please read this manual carefully.

We want X-System to make your job easier and your game day experience positive. To successfully familiarize yourself with the many diverse and powerful features X-System offers, it is crucial that you acquaint yourself with the manual.

We are committed to providing you with a high quality product that will deliver years of trouble-free service. Should you experience any problem with your CoachComm X-System equipment, whether it is under warranty or not, we will do our best to take care of your needs.

Thank you for choosing CoachComm for your sideline communication needs.

CoachComm LLC
205 Technology Parkway
Auburn, AL 36830
Phone: 334-321-2300
Fax: 888-329-2658
www.coachcomm.com

© 2016-2026 CoachComm LLC. All rights reserved.
Document Reference: D0000281_P

© Telex is a registered trademark of Telex Communications, Inc.
© Audiocom is a registered trademark of Bosch Security Systems, Inc.

Table of Contents

Safety Information	1
Electrical Safety.....	1
Battery Safety.....	1
Transit Safety	3
Protecting Yourself and Those Around You	5
Introduction	6
What makes X-System so different?.....	6
Frequency Considerations.....	6
New in Version 1.21	7
CoachComm X-System Player Mini.....	7
CoachComm X-System IP-Rated Radio Transceiver.....	7
Coach-to-Player Radio Transceiver Deployment.....	7
Stadium Wiring Considerations	8
Twisted Copper with RJ-14 Connector	8
Fiber-Optic Cable.....	8
Block Diagrams	10
Sideline to Wired Press Box Unit (System Diagram).....	10
Wired Press Box Unit Block Diagram	11
Sideline Cart Block Diagram	12
Game Day Setup.....	14
X-System Components	19
Sideline Cart Overview.....	19
Drive System Overview.....	22
Wired Press Box Unit Overview	25
PS-4001 Power Supply(s)	25
Wired Interface Module (WIM).....	26
Ringdown Circuits	28
Wired Assignment Module (WAM)	29
Sideline Cart Power Management.....	30
Sideline Cart Rear Patch Panel.....	33
Control Unit (XCU-44).....	34
Understanding the Control Unit's LEDs.....	36
Radio Transceivers (XRT-900, XRT-900-IPR, XRT-2400, and XRT-2400-IPR)	39
Radio Packs (XRP-13, XRP-22, and XRP-44)	41
System Accessories.....	50
Wired BeltPacks	50
Field and Press Box Cables.....	50
Headsets	51
System Configuration File	52
Saving a System Configuration File.....	52
Uploading a Configuration File	52
X-Ware	55
Home Screen.....	55
RP Icons.....	57
Profile Screen.....	59
Additional System Views.....	61

X-Ware Advanced Settings.....	67
Operational Modes	75
System Setup and Operation.....	78
RT Mast Assembly	78
Setting Home/Away Status	81
Turning On 2-Wire Ports and Adjusting Levels.....	81
Assigning Conferences to Dry Pair Connections (Wired Port)	82
Assign Profiles from the Control Unit.....	82
Wireless Component Setup and Integration.....	83
Understanding Link Quality	83
System Maintenance	84
Basic Maintenance	84
Off-Season Storage: Inverter Battery Information	84
Lithium-Polymer Battery Maintenance	85
Installing and Updating X-Ware.....	86
Updating Device Firmware.....	89
Product Support.....	92
Returning Equipment for Repair or Maintenance	92
License Information	93
Radio Device License Information	93
Non-Radio-Device License Information	94
X-Ware™ End User License Agreement (EULA)	95
Warranty Information	98
Limited Warranty	98
Parts Limited Warranty	98
Glossary	99
Specifications	100
Sideline Cart Specifications	100
Control Unit Specifications	101
Wired Pressbox Specifications.....	101
Radio Transceiver Specifications	102
Radio Pack Specifications.....	103
Sideline Accessory Case Specifications	106
Pressbox Accessory Case Specifications.....	106
Appendix A: Wireless Press Box Unit (WPB1)	107
Sideline to Wireless Press Box Unit (WPB1) (System Diagram)	107
Wireless Press Box Unit (WPB1) Block Diagram	108
Wireless Press Box Unit (WPB1) Overview.....	109
Wireless Press Box (WPB1) Rear Patch Panel.....	110
Using Fiber with Wireless Press Box (WPB1)	111
Using Dry Pair with Wireless Press Box (WPB1).....	112
Wireless Press Box (WPB1) Specifications	113
Appendix B: Wireless Press Box Unit (WPB2)	114
Sideline to Wireless Press Box Unit (WPB2) (System Diagram)	114
Wireless Press Box Unit (WPB2) Block Diagram	115
Wireless Press Box Unit (WPB2) Overview.....	116
Wireless Press Box (WPB2) Rear Patch Panel.....	118
Wired Interface Panel (WIP).....	119
Using Fiber with Wireless Press Box (WPB2)	121

Using Dry Pair with Wireless Press Box (WPB2).....	122
Wireless Press Box (WPB2) Specifications	123
Appendix C: CoachComm X-System Coach to Player Communication.....	124
Important Safety Information	125
CoachComm X-System Player Module	126
X-System Referee Cutoff	131
CoachComm to GSC Referee Cutoff Integration.....	138
X-System HUB.....	139
X-System Interface Panel.....	139
Coach to Player High Density RT Deployment.....	140
Appendix D: Standalone RT Mode	141
Required Equipment (Setup and Deployment)	141
X-Ware Setup	141
CoachComm X-System Setup	141
Standalone RT Operation Notes	142
Player Receiver Volume Control in Standalone Mode.....	142
Radio Transceiver (RT) Battery and Mount.....	143

Safety Information

The following pages detail important safety information related to the ownership and operation of CoachComm's X-System. Please ensure all personnel review the warnings and safety recommendations included in this document before operating, transporting, or towing the sideline cart in order to prevent equipment damage and/or serious personal injury.

Throughout this document you will see the following indicators for important safety information and alerts:



WARNING: Ignoring these warnings may cause permanent or serious injury or death as a result of incorrect operation.



CAUTION: Ignoring these cautions may cause moderate injury or property damage as a result of incorrect operation.

Electrical Safety



WARNING: ELECTRIC SHOCK RISK

- » Do not submerge any part of X-System in water.
- » Refer all servicing to qualified service personnel. Do not attempt to modify, disassemble, or open any X-System components. Exposing the electrical system may result in equipment damage and serious personal injury, including electric shock. Equipment damage caused by unqualified personnel may void the product warranty associated with your X-System.



CAUTION: SYSTEM DAMAGE RISK

- » Protect the power cords from foot traffic. Do not allow cords to be crimped or pinched, particularly at plugs, electrical outlets, and the point they exit from the apparatus. Routinely inspect power cords for any signs of fray or extensive wear. Immediately replace any damaged cords.
- » Keep all ventilation openings clean and unobstructed. Failure to do so could cause the system to overheat, which could cause personal injury or property damage.
- » Unplug X-System during lightning storms to prevent power surges that could damage electrical components or cause fire.
- » At a minimum, the X-System sideline cart requires one dedicated 15 amp 120V circuit. You should test and verify that any circuits are working properly on a routine basis.
- » In order to prevent voltage drop and damage to the system, a 3-wire grounded heavy-duty extension cord is required for use. CoachComm recommends using a cord 25 feet or less in total length for optimal performance.

Battery Safety

Sideline Cart Inverter Battery Safety



WARNING: EXPLOSIVE GASES RISK

- » Keep sparks, flames, and metal objects away from batteries, sideline cart, and area of operation. The gas exhaust from the batteries causes fire and explosions. This may cause SERIOUS INJURY or DEATH.
- » Ventilate the area when charging batteries or operating the sideline cart in an enclosed space.
- » CoachComm recommends keeping a Class-D fire extinguisher available when charging inverter batteries. Though the batteries are sealed, the gases inside are highly flammable.

**WARNING: CORROSIVE MATERIAL RISK**

- » Wear a full face shield, chemical-resistant gloves, and protective clothing/shoes when working on or near batteries.
- » Battery acid is a harmful, corrosive material and may cause permanent injury if it comes into contact with skin or eyes. If contact with skin or eyes occurs, immediately flush with water and seek medical assistance.

**WARNING: ELECTRIC SHOCK RISK**

- » The electricity stored in batteries can cause electric shock resulting in serious bodily injury or death, even at low voltages.
- » When servicing or inspecting electrical components, unplug from AC power and turn the battery bank breaker off to avoid electrical shock or damage to the electrical system.
- » Use insulated tools when working near batteries or electrical connections to avoid electrical shock or damage to the electrical system.

**CAUTION: SYSTEM DAMAGE RISK**

- » Perform a periodical visual inspection to check that all connections and battery cables are securely attached to the terminal and tight; improper connections can result in system malfunction, battery post breakages, meltdown, or fire.
- » Do not lay any objects on batteries or terminals to avoid short circuiting of components or wiring.
- » Do not wear metal jewelry such as rings, watches, chains, etc., when servicing the sideline cart batteries to avoid short circuiting of components or wiring.

Radio Pack (RP) Battery Safety**WARNING: EXPLOSION AND FIRE RISK**

- » Battery explosion is possible if incorrect type is used. Use only batteries approved for use with X-System Radio Packs. If powering the Radio Pack with AA batteries, use only alkaline or carbon-zinc batteries.
- » Do not leave the battery unattended while charging. Immediately unplug unit if battery begins to swell or emit smoke while charging. If battery bursts or chemicals begin to leak out of battery housing, the chemicals will react with the air and cause a fire.
- » CoachComm recommends keeping a Class-D fire extinguisher available when charging lithium-polymer batteries. The chemicals inside lithium-polymer batteries are highly flammable.
- » Do not allow batteries to overheat (reach temperatures of above 140 degrees Fahrenheit).
- » Batteries that appear swollen, deformed, or damaged, or that do not fit properly should never be used. Properly dispose of any batteries in this condition in accordance with the instructions provided by your local authorities. For more information and local drop-off sites, visit <http://www.call2recycle.org/>.

Transit Safety



WARNING: SEVERE INJURY AND SYSTEM DAMAGE RISK

- » Never allow individuals to stand, sit, climb, or ride on any part of sideline cart to prevent injury.
- » Never drive or tow sideline cart near drop-offs, ditches, or embankments; reduced traction could result in slippage, tipping, or other loss of control of your tow vehicle and/or sideline cart.
- » Never drive or tow sideline cart on the road shoulder or near slopes greater than 15%. Reduced traction could result in slippage, tipping, or other loss of control of your tow vehicle and/or sideline cart.
- » Never operate on wet or slippery slopes. Reduced traction could result in slippage, tipping, or other loss of control of your tow vehicle and/or sideline cart.
- » Do not turn on a slope. Reduced traction could result in slippage, tipping, or other loss of control of your tow vehicle and/or sideline cart.
- » Secure all system components, doors, and drawers before transit to prevent damage to those parts during transit.
- » CoachComm recommends having assistance from multiple people when the sideline cart is in transit. Additional people can provide visibility and terrain cues to the tow vehicle or drive system operator.

Drive System Safety



CAUTION: SYSTEM DAMAGE AND INJURY RISK

- » Ensure a tight grip on sideline cart drive system handle when in operation.
- » The emergency stop/reverse button on the drive system handle provides an immediate halt and brief reversal in the event of a collision or operator fall.

Utilize the drive system's horn button to signal the sideline cart's movements for nearby vehicles and people.

If the drive system is inoperable, it can be disengaged and overridden with the mechanical slider behind the back left wheel (accessible from the side of the cart opposite the drive system handle.)

Towing Safety

You should only tow the sideline cart behind a vehicle when the drive system is inoperable.

CoachComm recommends the following types of tow vehicles for the sideline cart: All Terrain Vehicle, golf cart or other electric towing vehicle, utility vehicle, or compact or sub-compact tractor.

If your tow vehicle will not travel by itself over the terrain by which you plan to tow the sideline cart, then it is not a suitable terrain for the sideline cart to traverse. In addition, most tow vehicles are capable of going over terrain that the sideline cart is not. Be cautious and find a different route to prevent equipment damage and a potential voiding of the X-System warranty.

WARNING

- **Only authorized individuals allowed to operate and drive cart**
- **Read all instructions and warnings before operating cart**
- **CoachComm recommends using a spotter when driving the cart**
- **Ignoring the warnings may cause serious injury or death**

Figure 1: Drive System Handle Label

When towing your sideline cart behind a vehicle, follow the safety instructions below:



CAUTION: SYSTEM DAMAGE AND INJURY RISK

- » Have a complete working knowledge of your tow vehicle and know how to handle it with the sideline cart attached.
- » Make sure the sideline cart's brake is disengaged via the mechanical slider prior to towing. Failure to do so will result in drive system damage.
- » Turn off the battery bank breaker and ensure the system is disconnected from AC power prior to towing.
- » Make sure towing hitch connections are properly secured prior to towing. Only use the manufactured sideline cart hitch to connect to the tow vehicle; do not connect a vehicle to the cart's drive system or axle. Failure to do so may result in sideline cart damage or injury.
- » Drive at a maximum speed of 3 mph. Higher speeds may cause a tip hazard or damage to the electric drive system.
- » Avoid sharp turns to prevent damaging the front steering system.
- » Decrease speed at all corners, and watch the swing of both the rear of the tow vehicle and the sideline cart.

Parking Safety

The sideline cart drive system uses a magnetic brake, which engages as a wheel brake and parking brake when the drive system is powered off.



CAUTION: SYSTEM DAMAGE AND INJURY RISK

- » Never park the sideline cart on a steep grade or slope. Reduced traction could result in slippage, tipping, or other loss of control of the sideline cart.
- » Install and adjust the sideline cart stabilizers on all four corners of the sideline cart to prevent tipping when parked and in use.
- » Do not use blocks to increase height of system.

Transportation Safety

When transporting your sideline cart in a truck, follow the safety instructions below to prevent damage to your system or nearby equipment.



CAUTION: SYSTEM DAMAGE RISK

- » Secure the cart in your truck using the tie-down points indicated in Figure 20 and Figure 21 on page 21 of this manual.
- » CoachComm recommends tying down with four (4) cargo straps rated for at least 5000 lbs.
- » Always ensure that the sideline cart's brake is engaged. (The brake lever should be in Position A as indicated on page 22 of this manual.)
- » Protect the corners and edges of your cart by padding them with cardboard.
- » Stop often to check your load.
- » Inspect cargo straps often and replace them if any damage is noted.

Protecting Yourself and Those Around You

Allow only responsible individuals who are familiar with these general safety rules and operating instructions to use your X-System. Never allow people unfamiliar with these rules and instructions to set up or operate your system.



WARNING: SEVERE INJURY AND SYSTEM DAMAGE RISK

- » The Radio Transceiver mast is top-heavy and can be a crush hazard. Ensure a tight grip when engaging or releasing safety pins to prevent serious personal injury or system damage.



CAUTION: SYSTEM DAMAGE AND INJURY RISK

- » The drive system handle and sideline cart doors, drawers, and compartments can be pinch hazards. Utilize all installed safety pins on movable components.
- » Never, under any conditions, remove, bend, cut, fit, weld, or otherwise alter standard parts of the X-System. Modifications to your system could cause personal injuries and property damage and will void your warranty.
- » Only use attachments/accessories/cables/hardware provided by the manufacturer.
- » Do not remove or cover any safety labels on the sideline cart. If a label is damaged or removed, contact a CoachComm support technician for a replacement.

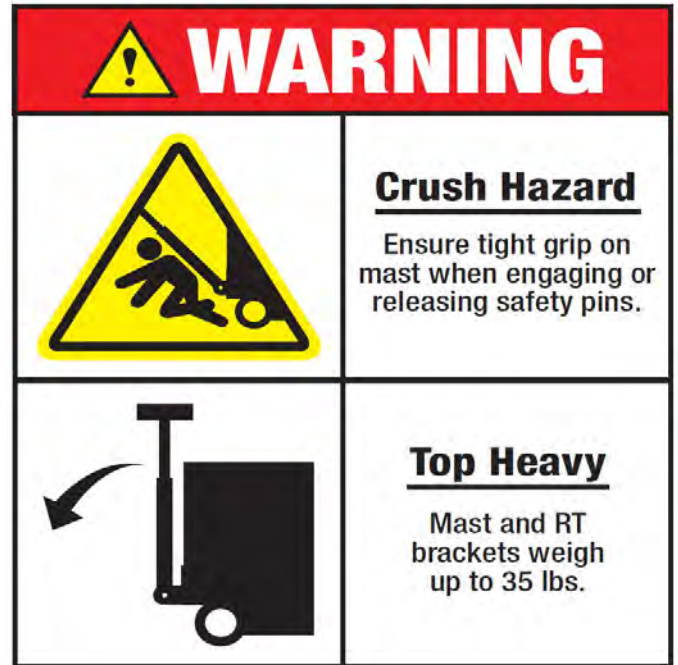

Figure 2: Crush Hazard Label

Introduction

What makes X-System so different?

CoachComm has been building and providing wired and wireless systems for over 25 years to supply quality communications to D-1 teams nationwide. CoachComm's knowledge of wireless technology in the D-1 football arena is vast, and our experience is deep. When it came time to build the next generation of equipment to service that industry—CoachComm was up to the challenge.

X-System makes use of the newest available communications technology and meets our customers' demands for more users, better audio, and future-based features.

X-System is the first wireless intercom system to innovate the following unique features:

- Better Frequency-Hopping Spread Spectrum performance in domes
- Enhanced 900MHz and 2.4GHz band wireless performance
- X-Ware touchscreen user interface for greater visibility and control of the system
- State-of-the-art rugged and stable Sideline Cart design
- Better 7k audio quality

These features come together to form a powerful product called X-System. X-System, together with enhanced tools for the wired portion of the system, makes for an incredibly robust, easy-to-operate system.

Frequency Considerations

900MHz and 2.4GHz

CoachComm designed the new X-System to operate seamlessly in both the 900MHz and the 2.4GHz frequency bands. This allows multiple devices to operate within the bands with minimal interference or reduction of range and performance.

The 2.4GHz ISM frequency band is a globally accepted portion of the RF spectrum that is available for unlicensed use virtually anywhere worldwide with no frequency coordination. In the United States, the 2.4GHz band is 2400–2483.5 MHz. X-System utilizes up to 83 MHz of this spectrum from 2400–2483 MHz.

The 900MHz ISM frequency band is a portion of the RF spectrum available for unlicensed use in North America and other various locations with no frequency coordination. In North America, the 900MHz band is 902–928 MHz. X-System utilizes up to 26 MHz of this spectrum.

Frequency-Hopping Spread Spectrum

Frequency-Hopping Spread Spectrum (FHSS) is a means of RF transmission. In FHSS, the signal hops to various frequencies—hence the name. In doing so, it spreads the data (voice in our case) across a wide area of the RF spectrum. Devices such as those in X-System collide constantly with other devices in that frequency spectrum and must have mechanisms built into their protocol to allow for data redundancy to provide acceptable user performance.

New in Version 1.21

CoachComm X-System Player Mini

The new XRP-CP01M-900 Player-worn Radio Pack Mini Module can be added as an upgrade package to the X-System line that will allow for coaches to communicate with players either in a practice or game day environment. Its small size, robust housing, and simple interface allow it to be placed where needed. Integration into the X-System is seamless as software connectivity will allow for full control and routing of audio from coaches to players as needed.

See “Appendix C: CoachComm X-System Coach to Player Communication” on page 124 for more information about the X-System Player Upgrade.

Note: *Products and software associated with X-System Player and Referee Interrupt are only functional with the X-System Player upgrade package.*

CoachComm X-System IP-Rated Radio Transceiver

Recently, there has been a running change to the construction of all CoachComm X-System Radio Transceivers (RTs). For any new purchases, these RTs will be our new IP-Rated (weather resistant) product which allow them to be placed outside in the elements without the need for any addition bag or cover. Support of this new model of RT is now included in this latest version of firmware. See “Radio Transceivers (XRT-900, XRT-900-IPR, XRT-2400, and XRT-2400-IPR)” on page 39.

Coach-to-Player Radio Transceiver Deployment

In an effort to maximize RF performance and convenience when deploying the CoachComm X-System (X-Cart and ATA) with Coach-to-Player (C2P) communications, we have made a change to our recommendations on Radio Transceiver (RT) deployment. A recent firmware (FW) update (v1.21.0.34) now allows for the High Density-Mode RT to be mounted on the same main mast as the other Normal-Mode enabled RTs and now no longer requires a separate High Density-Mode RT to be mounted on a tri-pod and be placed at least 25 yards from the main mast. This change is made possible due to the creation of a co-location mode (now the default mode) added to the settings of High Density-Mode RT. Please note that this mode has changed the ability of “Coaches” packs to log into this co-located RT. In this new mode, only two XRP-13 coaches packs can be talkers at the same time, as opposed to four when co-location mode is disabled. This means that it is recommended that you keep as many listen-only devices as possible on the High Density-Mode RT since there are limitations as to how many coaches can talk simultaneously.

Note: *This change in deployment ONLY applies to systems running FW of v1.21.0.34 or higher with an RT set to High Density (Co-location Mode On) and specifically used for C2P communications. Also, this change has no effect on 2.4 GHz antennas used with the wireless press box for coaches upstairs; this is ONLY for 900MHz field RTs.*

Connect the HiDen RT to the Loop Out of the last RT on the mast. Do NOT connect to the X-Net port on the C2P connection panel on the back of the X-Cart. As a reminder, CoachComm also recommends that all RTs now be mounted on the same side of the mast with all antennas deployed at a 45-degree angle. This orientation maximizes spacing between antennas and minimizes interaction between them as well.

See “Coach to Player High Density RT Deployment” on page 140 for example images of RT deployment.

Stadium Wiring Considerations

Twisted Copper with RJ-14 Connector

CoachComm recommends an uninterrupted run of Cat 3 UTP cable from sideline to press box (for both home and visitor). By definition, each RJ-14 connector has two pairs (i.e., four wires). It is often confused with an RJ-11 (two wires). Some phone technicians will call these RJ-11 4-wire jacks.

Specifications:

- Max Distance ≤ 3000 ft. (914.4 m)
- Connector Type RJ-14
- Wire Type Cat 3 UTP (unshielded twisted pair) copper phone line (At least 12 pairs required, though we recommend 24 pairs in order to have a full backup set.) Each RJ-14 connection consists of 2 pairs wired.
- Wire Size 22 to 24 AWG

Please note the unique wiring of the RJ-14 for the “NG” application in Figure 3.

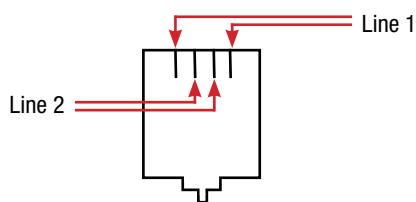

Figure 3: RJ-14 Wiring

CoachComm System (RJ-14 Connections)	Stadium Wiring (RJ-14 Connections)
Lines 1/2	Pairs 1 and 2
Lines 3/4	Pairs 3 and 4
Lines 5/6	Pairs 5 and 6
Lines 7/8	Pairs 7 and 8
Ground 1/Ground 2	Pairs 9 and 10
Ringdown 1/Ringdown 2	Pairs 11 and 12

Fiber-Optic Cable

Requirements for use with X-System Wireless Press Box Unit

For stadium wiring, CoachComm recommends an uninterrupted run of at least eight strands of single-mode optical fiber (SMF) cable from sideline to press box (for both home and visitor). We require at least four strands for X-System operation, so strands beyond those would be spares.

The X-System® Sideline Cart, ATA package, and Wireless Press Box systems contain Neutrik OpticalCon Duo panel connectors and cables. (Neutrik OpticalCon Duo Connectors are ruggedized pass-through connectors compatible with standard LC duplex terminated fiber cable.) For ease of use, CoachComm recommends using Neutrik OpticalCon Duo Chassis Connectors for field and press box stadium termination.



Figure 4: Single-Mode Fiber (2 Strands) and Duplex LC Termination



Figure 5: Neutrik opticalCON DUO Cable Connector

Specifications:

Max Distance	≤ 10 km (6.2 miles)
Fiber Type	9/125 μm Single-Mode Fiber (SMF) strands (At least 4 strands required, though we recommend 8 strands in order to have a full backup set.) Each LC duplex connection consists of 1 pair (i.e., 2 strands).
Connector Type	LC duplex pair into Neutrik OpticalCon Duo (Part # NO2-4FDW-A)
Stadium Termination	At least 2 separate Neutrik OpticalCon Duo panel connectors on the sideline and in the coaches box connected via LC duplex fiber terminated in an A to B orientation as detailed in TIA standard for fiber cabling components standard TIA-568-C.3 section 6.4.2.1.



Figure 6: Neutrik opticalCON DUO Chassis Connector

Excerpt from TIA-568-C.3 section 6.4.2.1:

A-to-B duplex patch cords shall be of an orientation such that Position A connects to Position B on one fiber, and Position B connects Position A. Each end of the patch cord shall indicate Position A and Position B if the connector can be separated into its simplex components. For connector designs utilizing latches, the latch defines the positioning in the same manner as the keys.

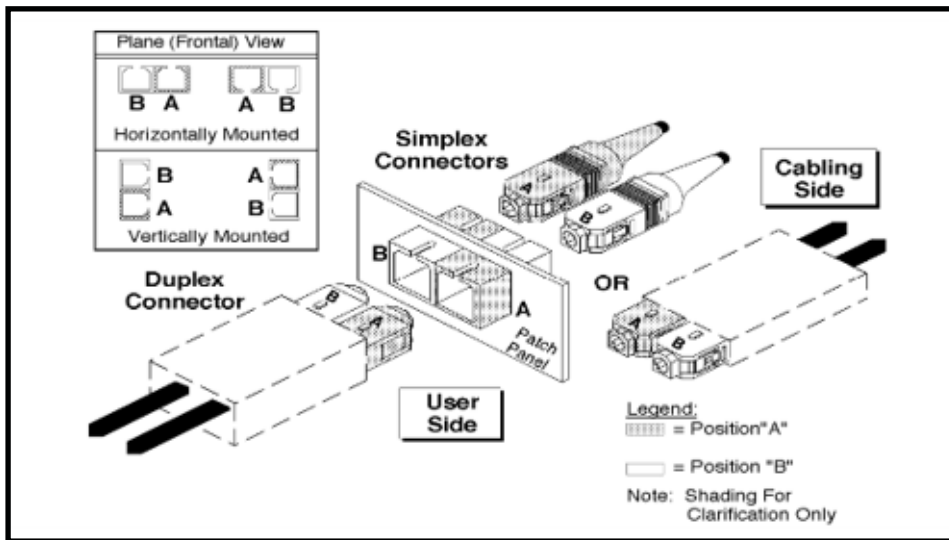

Figure 7: Image Excerpt from TIA-568-C.3 section 5.2.1.3.1

See Figure 140 and Figure 144 in the Appendices for Wireless Pressbox fiber wiring diagrams.

Block Diagrams

The following pages contain block diagrams that represent the principal parts of X-System and their relationships.

Sideline to Wired Press Box Unit (System Diagram)

See page 25 for more information about the Wired Press Box Unit. See page 33 for more information about the Sideline Cart Patch Panel.

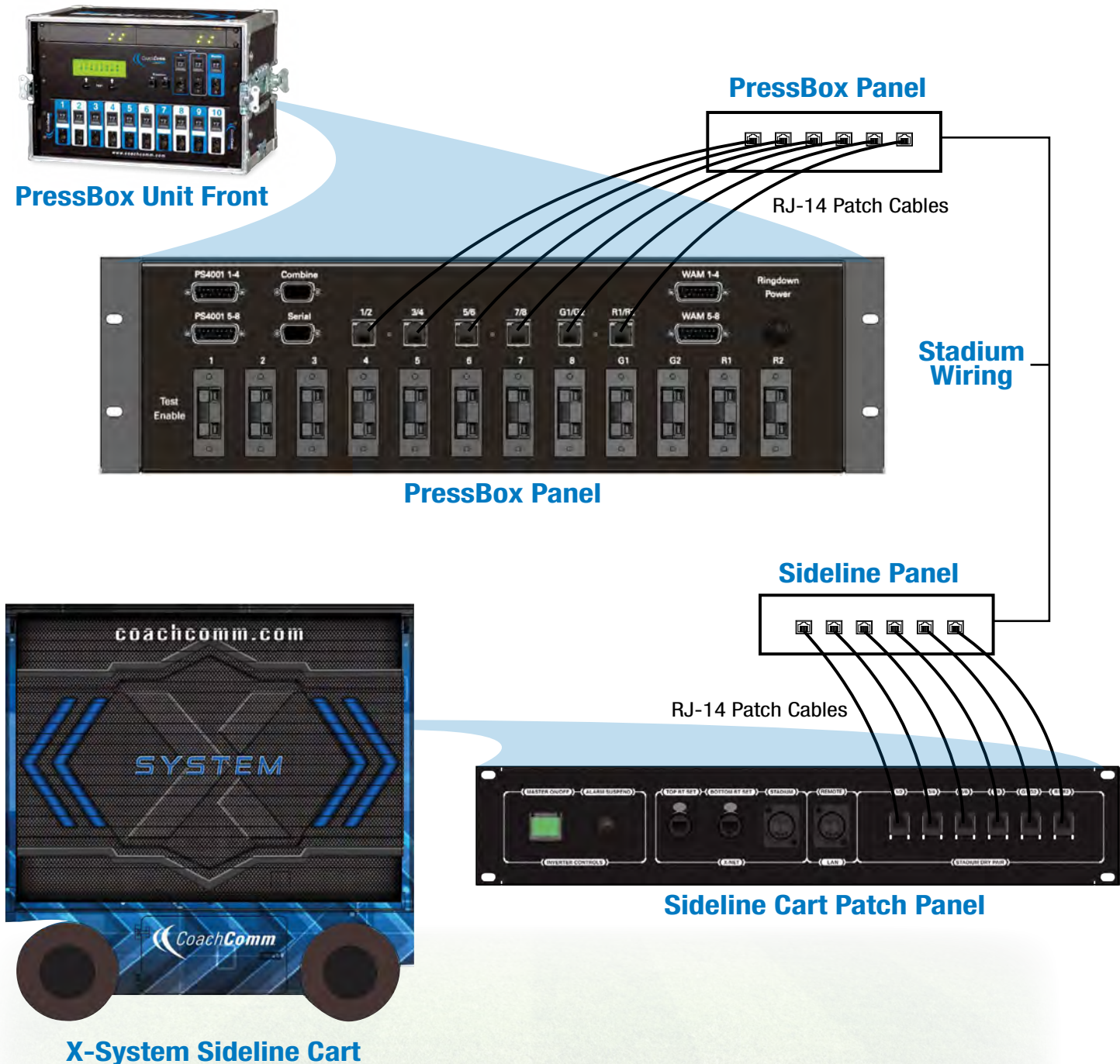

Figure 8: X-System Block Diagram

Wired Press Box Unit Block Diagram

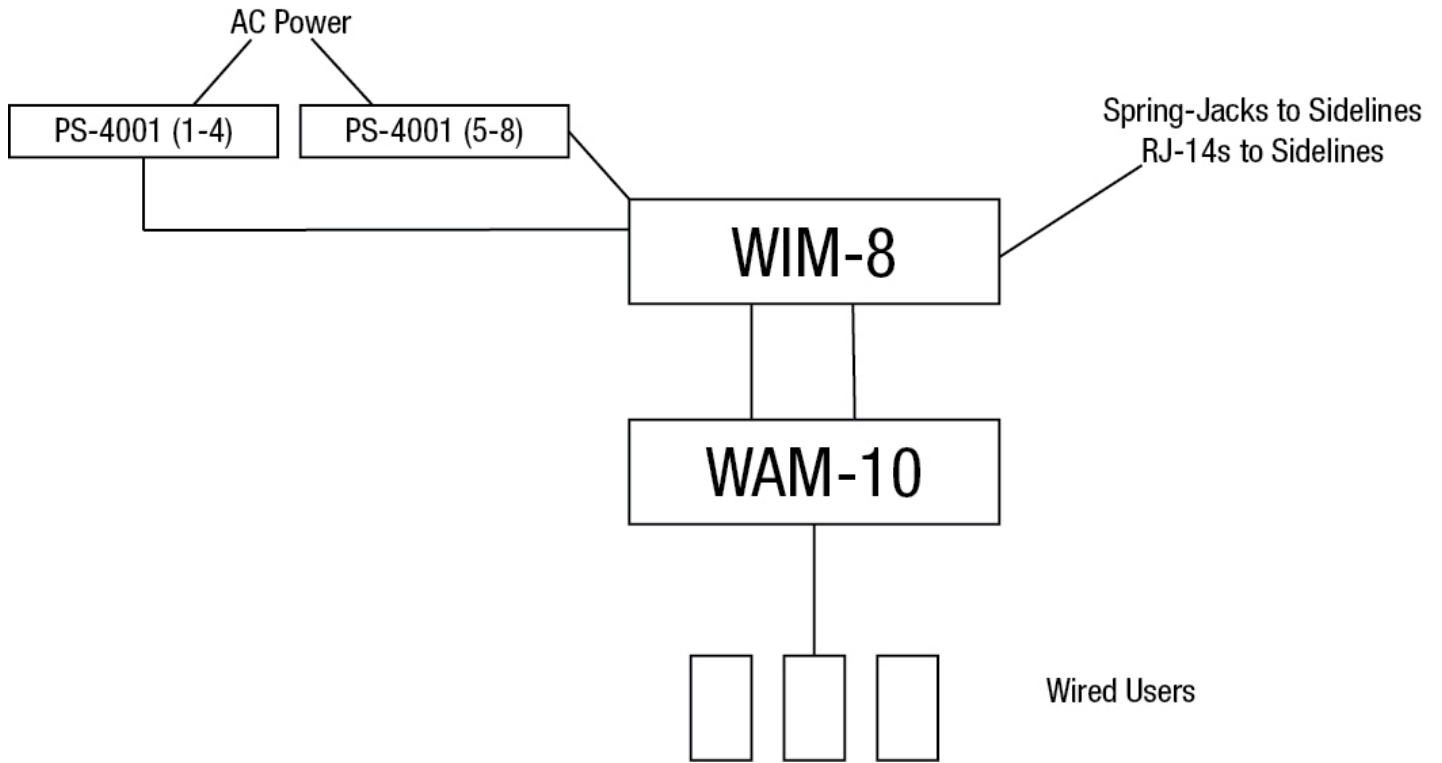

Figure 9: Wired Press Box Unit Block Diagram

Sideline Cart Block Diagram

Without X-System Hub and X-System Interface Panel

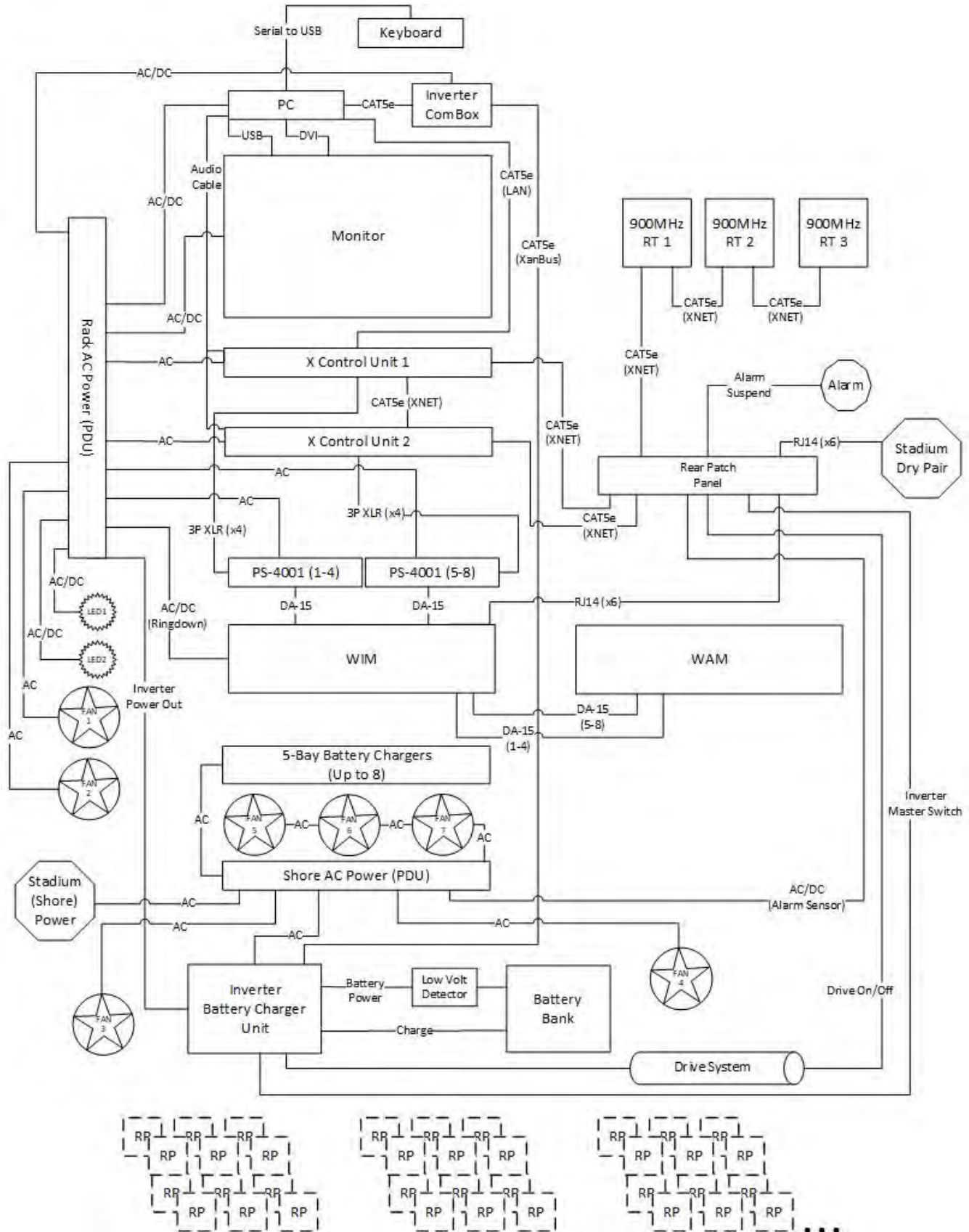

Figure 10: Sideline Cart Block Diagram (with Hub & Interface Panel)

With X-System Hub and X-System Interface Panel

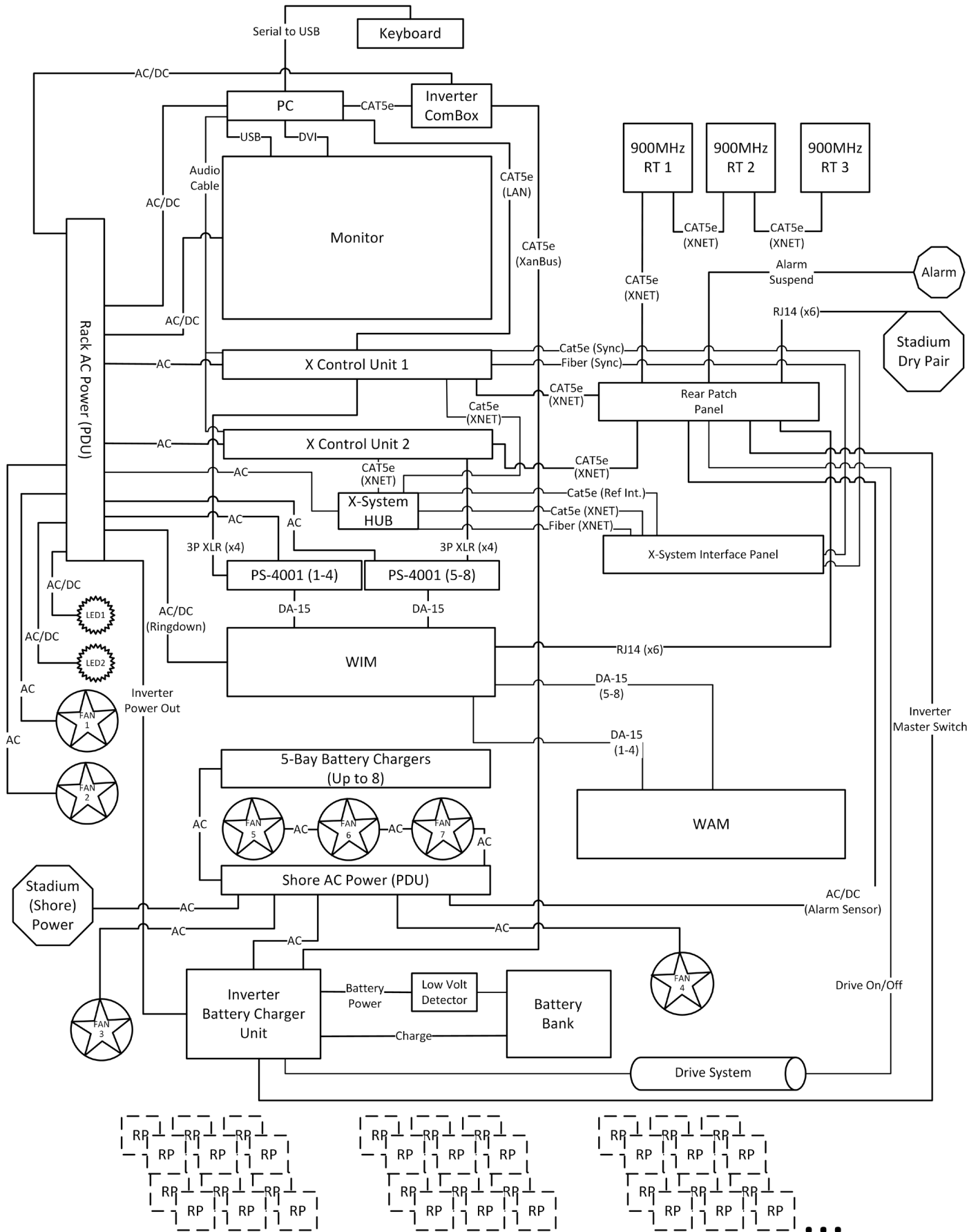

Figure 11: Sideline Cart Block Diagram (without Hub & Interface Panel)

Game Day Setup

The procedures in this section serve as a reference for a typical game day setup. You can find more in-depth information about the devices and processes mentioned here in later sections of this Operating Manual.

Note: If you are setting up a Wireless Press Box Unit, additional Game Day Setup instructions are provided in this document's Appendix A and B starting on page 107.

Getting Started

This Game Day Guide is a basic reference for setting up your X-System. For complete operation instructions, see the rest of this manual.



CAUTION: Allow only responsible, authorized individuals who have read all of the instructions and warnings to set up and operate your X-System.

Provided Tools:

- 1/2" socket wrench
- Drill bit adapter (1/4" hex to 1/2" square) for use with any 1/4" drill or cordless screwdriver

Additional Tools You May Need:

- 1/4" drill or cordless screwdriver

Required Power Connection:

- Minimum of one dedicated 15 amp 120V circuit

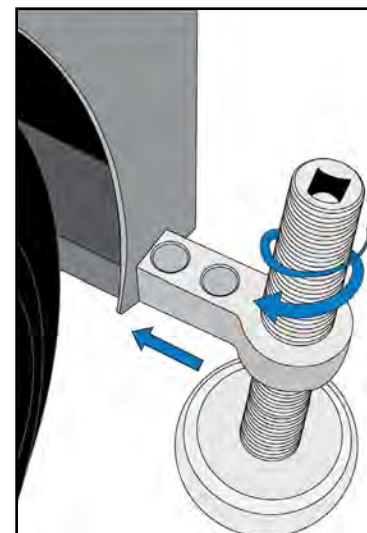

Figure 12: Sideline Cart Stabilizer

1. Position and stabilize cart.

- 1a. Once the Cart is positioned at midfield, insert each of the four stabilizers into their associated slots.
- 1b. Extend the stabilizers to the ground using either the socket wrench or the drill bit adapter and drill. Continue extending until stabilizers have made sufficient ground contact to stabilize the cart.

Note: The cart stabilizers are not intended to lift the cart.

2. Prepare RT Mast

Note: The following steps are referenced in Figure 13 and should be performed with at least two people.

- 2a. Remove the mast from its storage area and insert it into the locked and upright mast receiving tube.
- 2b. Align the mast so your RT mounting bracket(s) (when attached) will be parallel to the sideline and secure the mast with pin 1 at the bottom of the tube.
- 2c. Secure the mast and tube with one hand, then remove pins 2 and 3 from the top of the tube. Carefully lower the mast to a bench or chair level with the cart. (See Figure 122 on page 79 for a detailed drawing of these pin locations.)



CAUTION: Ensure there is a minimum of 20 feet of clearance beside the Cart before lowering the mast.

- 2d. Extend the mast to the desired height, locking each section in place as you go. (A minimum of 12 feet is recommended.)
- 2e. If you are not fully extending the mast, align the index holes of the non-extended sections and secure by inserting pin 4. This prevents the mast from rotating while extended. (See Figure 122 on page 79 for drawing of pin locations.)

3. Mount RTs and secure mast.

Note: The following steps are referenced in Figure 13 and should be performed with at least two people.

3a. Mount the RT mounting bracket(s) to the top of the mast using the provided pins.

3b. Connect the red RT cable to the first RT on the top bracket.

Note: If using a second RT bracket, also connect the blue RT cable to the first RT on that bracket.

3c. Attach the cable's strain relief to the eye bolt on the mounting bracket.

3d. Bend the antennas so they are at a 45° angle between the antenna and the RT and align the mast so the RT bracket is parallel to the field as shown in figure below.

3e. Carefully walk the mast up until the receiving tube is upright and flush with the Cart, then secure it with pins 2 and 3 (previously removed in 2c). (See Figure 122 on page 79 for a detailed drawing of these pin locations.)

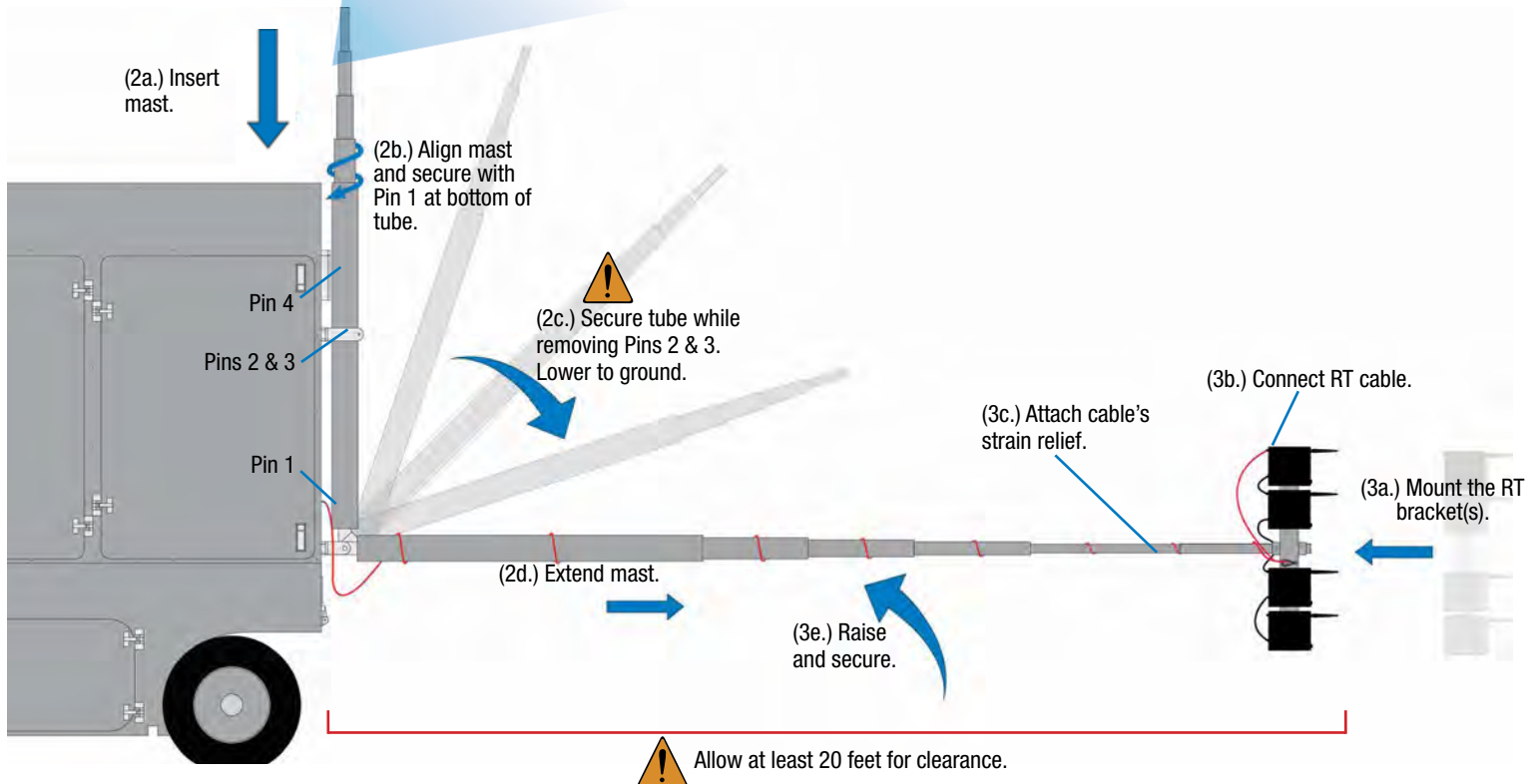
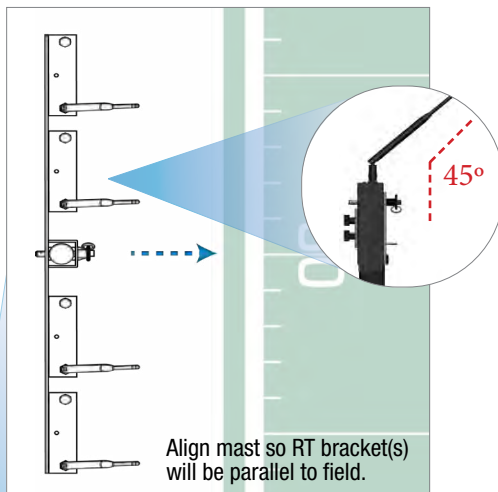

Figure 13: Sideline Cart RT Mast Setup

4. Connect RT cable and dry pair to cart.

4a. Connect the red RT cable to the “TOP RT SET” port on the Cart’s rear rack patch panel.

Note: If using a second RT bracket, connect the blue RT cable to the “BOTTOM RT SET” port.

4b. Connect stadium’s dry pair panel to the corresponding “STADIUM DRY PAIR” ports on the rear patch panel.

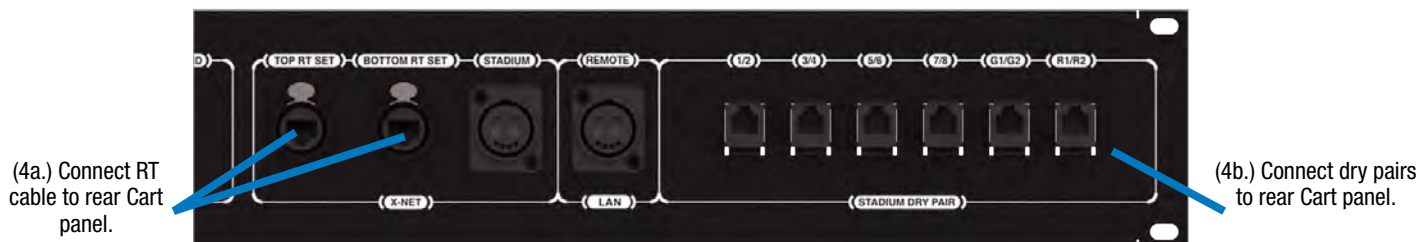

Figure 14: Patch Panel RT Cable and Dry Pair Ports

5. Connect AC power and power on the cart.

5a. Route an external power extension cord through the Cart’s hatch and connect it to the main AC power cord in the rear of the Cart. At a minimum, the cart requires one dedicated 15 amp 120V circuit.



WARNING: DANGER! Users should exercise extreme care when working with electricity. Additional care should be used when working with electricity outdoors in inclement weather. When working outdoors or near water, always connect the system into a ground-fault interrupting circuit.



CAUTION: Secure and protect any cords to prevent walkway hazards and potential contact with moisture.

5b. Power on the Cart via Master On/Off switch on the Cart’s rear panel. (See Figure 15.)

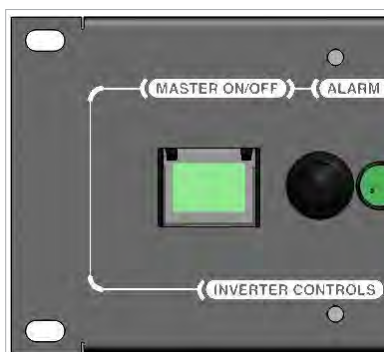

Figure 15: Patch Panel Master On/Off Switch

5c. Confirm that all devices on the front rack are powered on, including the AC power distribution unit, Control Unit(s), and monitor.

6. Set Home/Away status.

6a. Follow the prompt on the top CU to set your system's Home/Away status.

Important: No RF transmission will occur until the Home/Away status is selected. Failure to set this status properly may result in RF interference.

The Home/Away setting aids customers with hopping pattern coordination between RTs and Radio Packs. Based on this setting, all of the RTs on the system will be assigned specific hopping patterns by the Control Unit (CU). It is very important to set this status correctly. Hopping pattern coordination prevents interference between X-Systems.

During startup, the configuration file (CCF) will begin loading while the Home/Away prompt is displayed on the top CU. A progress bar shows the load process on the bottom CU. Once the Home/Away prompt is cleared, the CCF load progress can be seen on both CUs.



Figure 16: CU Home/Away Prompt at Startup

6b. Wait until the CUs display the “CCF Loaded” message along with a configuration file summary. (The bottom CU will take about 30 seconds longer than the top.) When the CCF load is complete, the home screen will display on the front of the CU(s) and you can proceed.

6c. Open X-Ware and allow its Home screen to load.

7. Set up press box unit and null system.

Note: The procedures in this step should be performed by at least two people.

7a. Once the Sideline Cart is configured, set up and connect power to the Press Box Unit. Have someone stay with the Sideline Cart to assist in the verification of dry pairs during this step.

7b. Connect dry pair panel in the Press Box to the corresponding ports on the rear of the WIM in the Press Box Unit.

7c. Connect wired BeltPacks and cables for each coach. Make sure all TALK buttons are off.

7d. Auto-null all of the lines from the sideline using X-Ware's Conference view (under the System Settings menu). If there is noticeable echo on some channels of the wireless components, confirm that all TALK buttons are off and repeat the auto-null step.

8. Power on and walk test Radio Packs and Player Modules.

The procedures in this step should be performed with at least two people.

- 8a. Install a fully charged Lithium-Polymer rechargeable battery or three AA alkaline batteries in each Radio Pack (RP).
- 8b. Power on the first two RPs by pressing and holding the Power button on the back of the RP for 3 seconds.
- 8c. Confirm each RP is on the same conference, connect a headset to each RP, and conduct a walk test to confirm their operation. The RP's LQ value can be used to gauge performance.

Important: Each tester should walk their RPs to opposite goal lines and back, ensuring clear communication between all RPs. Always place the RP on the hip opposite from the press box when walk testing.

- 8d. After walk testing is complete, place the RP down on a table or bench. Be sure to place each RP a foot or so apart; bunching RPs together could impact wireless performance. Repeat steps 8b-8c for each of the remaining RPs.

Important: If raining, cover the RPs or return them to their drawer.

- 8e. Connect batteries and speakers to all CoachComm X-System Player Modules to turn them on. Walk test the entire field. Repeat walk test for all remaining Player Modules.

Important: Player Modules should be over shoulder height for walk test.

- 8f. Confirm communication between wireless and wired coaches.



Figure 17: Radio Pack Setup

9. Power off and stow away X-System.

Once your event has ended, power off and properly stow away all X-System sideline cart components.

- 9a. Power off all RPs and stow them in their storage drawers.



CAUTION: Thoroughly dry off any moisture prior to storage.

- 9b. CoachComm recommends saving a backup copy of your system configuration file to the PC desktop or a USB drive. Then, close X-Ware and shut down the PC.
- 9c. Power off the CU(s) then the cart's Master On/Off switch on the rear panel. Unplug and remove your extension cord.
- 9d. Carefully lower, disassemble, and stow the RT mast and RT mounting bracket(s), stowing them in their assigned sections of the Cart.



CAUTION: Maintain safe control of the mast and receiving tube throughout disassembly.

- 9e. Reinstall pins 2 and 3 once the mast is removed and the receiving tube is returned to its cradle.
- 9f. Remove the four Cart stabilizers, then stow them in their assigned sections of the Cart.

X-System Components

Sideline Cart Overview

The X-System Sideline Cart houses the communications hardware and PC infrastructure that establish X-System and subsequent X-Net network. In addition, it houses the wired back-up system and provides storage for related X-System accessories such as Radio Transceivers (RTs), Radio Packs (RPs), and Headsets.

The Sideline Cart should be positioned on the sideline at or near midfield within reasonable distance to necessary stadium dry pair connections and power. Be sure to set an adequate perimeter around X-System to ensure it does not interfere with coaches, players, or other game day personnel inside the coaches' box. The following is a list of hardware and accessories that reside inside the Cart:

Front View

- A. **Front Rack** - 23RU shock-mounted rack area with acrylic pocket door that contains the following:
- 19" Touchscreen Monitor**
 - X-System Control Unit(s)** (CUs) - (See page 34 for more information.)
 - Pull-Out PC Keyboard**
 - X-System HUB** - (See page 139 for more information.)

Note: Products and software associated with X-System Player and Referee Interrupt are only functional with the X-System Player upgrade package.

- PS-4001 AudioCom® Power Supply(s)** - (See page 30 for more information.)
- Wired Interface Module (WIM)** - (See page 25 for more information.)
- 5-Bay Battery Chargers** - Mounted in open-air drawer with rear ventilation fans (See page 45 for more information.)

viii. **AC Power Distribution Unit** (1RU) - (See page 30 for more information.)

- B. **Work Space** - Provides a dry, LED-lit place to prep equipment. Location of Inverter Alarm and stabilizer storage.
- C. **Drawer(s)** - Provides storage for Radio Packs, headsets, and additional tools
- D. **Stabilizing Slots** - Insertion points for cart stabilizers
- E. **Power Bay Access** - Houses the cart's AC Inverter and Battery Bank system (See page 30 for more information.)

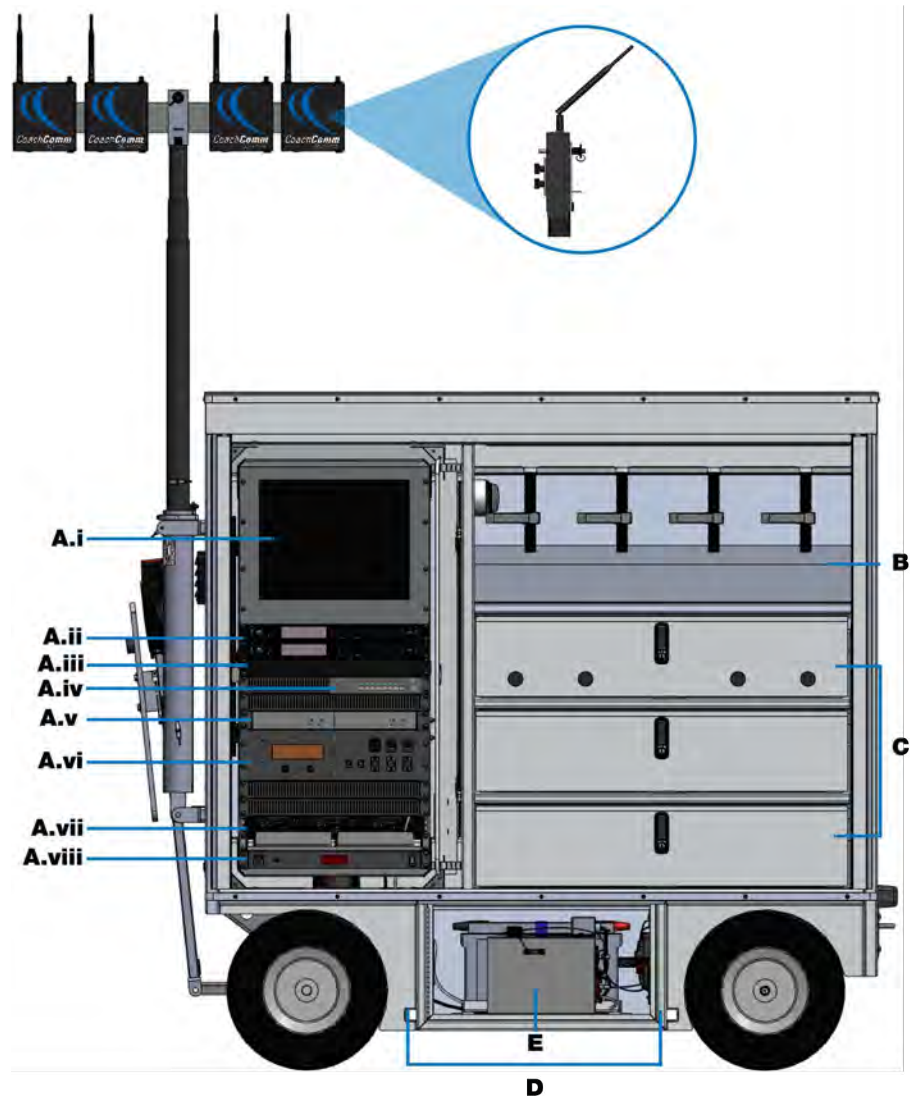

Figure 18: Sideline Cart Front View

Rear View

- A. **RT Storage** - Houses RT brackets (See page 78 for more information.)
- B. **Rear Rack** - 23RU shock-mounted, LED-lit rack area that contains the following:

- i. **Inverter ComBox** - Provides status information for AC Inverter to the PC (See page 32 for more information.)
- ii. **PC** - Provides interface with X-Ware (Intel® Core™ i3 processor, 4GB RAM, 256GB hard drive, and Windows® 7 operating system)
- iii. **Wired Assignment Module (WAM)** - (See page 29 for more information.)
- iv. **X-Player I/O Panel** - (See page 139 for more information.)

Note: Products and software associated with X-System Player and Referee Interrupt are only functional with the X-System Player upgrade package.

- v. **Drive System Switch** - Provides power to the drive system (See page 23 for more information.)
- vi. **Rear Patch Panel** - Contains Main Power Switch, Alarm Switch, RT connections, and dry pair connections (See page 33 for more information.)

- vii. **Inverter Outlet** - Inverter power for Rack Power Distribution Unit. Rack components powered by inverter in case of AC power loss.
- viii. **AC “Rack” Power Strip** - Supplies power to rack components (See page 32 for more information.)
- ix. **Fans** - Circulate air to 5-Bay Battery Chargers

- C. **Stabilizing Slots** - Insertion points for cart stabilizers

- D. **Power Bay Access** - Houses the cart’s AC Inverter and Battery Bank system (See page 30 for more information.)

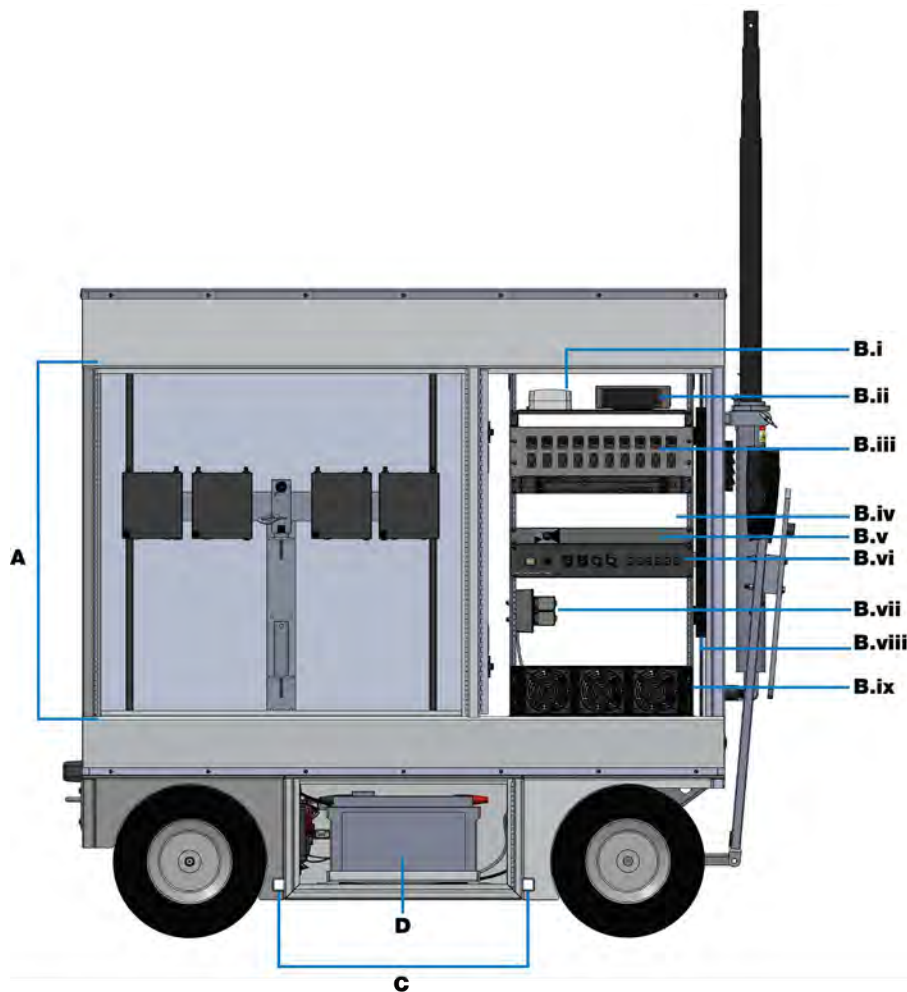

Figure 19: Sideline Cart Front View

Side Views

- A. **Drive System Handle**
- B. **Mast Tube** - Houses the RT mast when in use (See page 78 for more information.)
- C. **Mast Storage** - Houses the RT mast when not in use
- D. **Cable Hatch** - Access point for cables through side of cart
- E. **Left Tie Down Points** - When transporting the cart in a truck, secure straps to the two provided tie-down holes on the vertical frame of the cart's axle.
- F. **Brake Lever** - Determines the behavior of the Drive System magnetic brake
- G. **Right Tie Down Points** - When transporting the cart in a truck, secure straps to the two provided tie-down rings on the cart's right side.

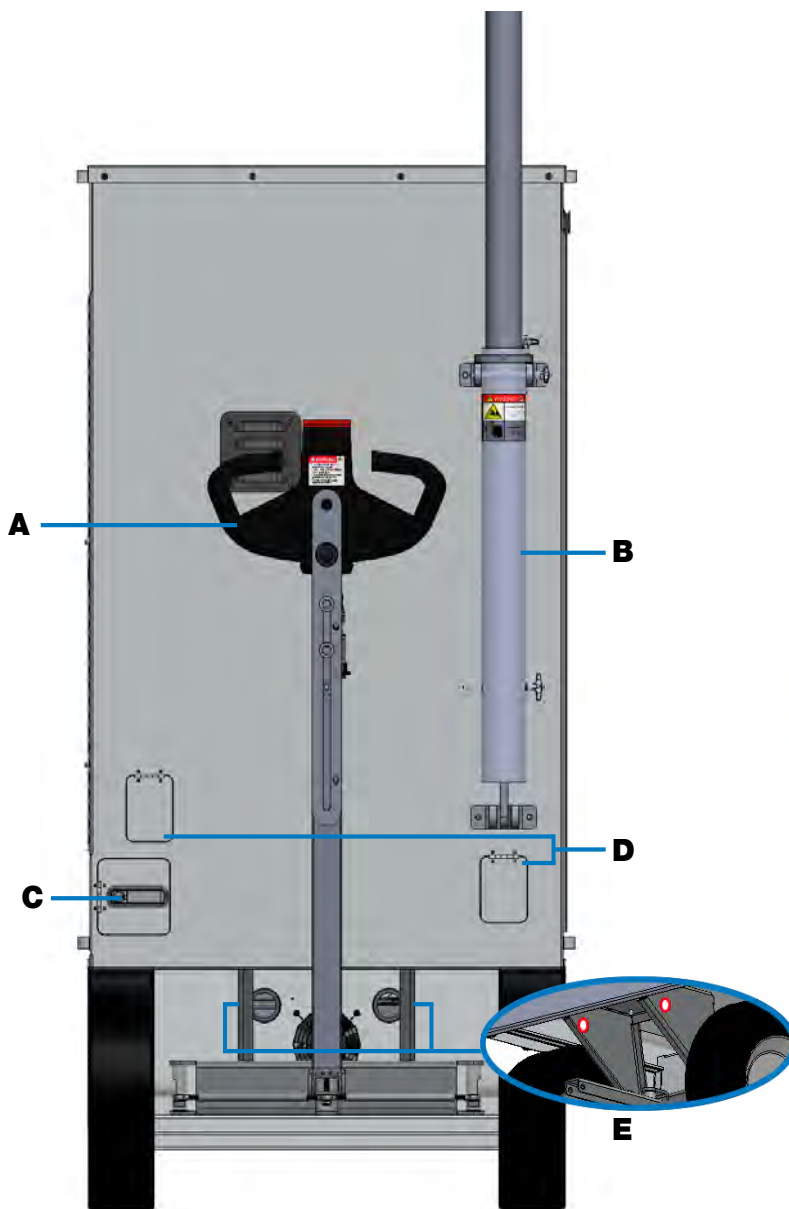

Figure 20: Sideline Cart Left Side View



Figure 21: Sideline Cart Right Side View

Drive System Overview

This section is a basic reference for using your X-System sideline cart's drive system.

CAUTION: Allow only responsible, authorized individuals who have read all of the instructions and warnings to operate and drive the cart. CoachComm recommends using a separate spotter when driving the cart.

Brake

The sideline cart drive system uses a magnetic brake, which acts as a wheel brake and parking brake when the drive system throttle is not in use. Even with no power to the cart, the brake is engaged.

- When using the cart's drive system, the brake lever (located between the wheels on the side opposite the tow handle) should be in Position A (Figure 22).
- In the event of a loss of battery power or another issue with the drive system, the cart can be manually towed. In this case, the brake lever should be in Position B (Figure 23), and the cart should be towed at a maximum speed of 3 mph. Higher speeds may cause a tip hazard or damage to the electric drive system.

First-Generation Cart - Position A

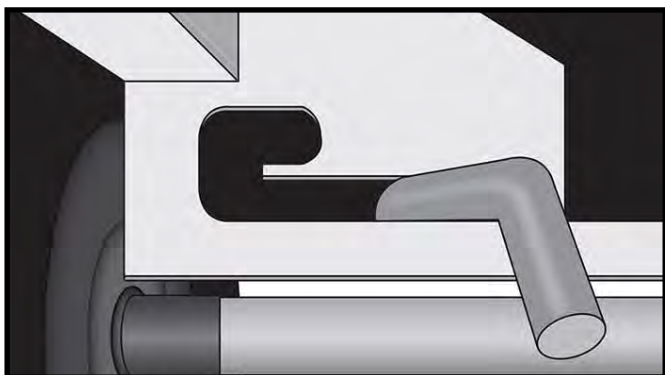

Figure 22: First-Generation Cart Brake Lever Position for Drive System Operation

First-Generation Cart - Position B

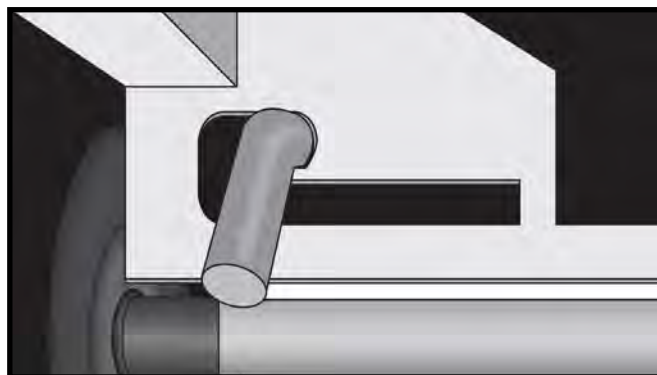

Figure 23: First-Generation Cart Brake Lever Position for Manual Towing

Note: Second-generation model X-System carts (those with a black top) have a different brake lever than first-generation carts (those with a silver top). See Figure 24 and Figure 25 below.

Second-Generation Cart Position A

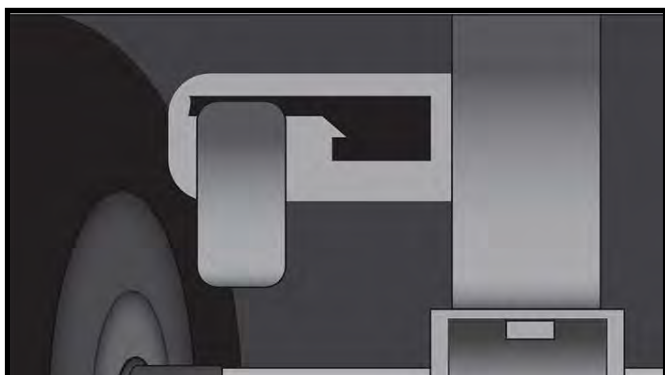

Figure 24: Second-Generation Cart Brake Lever Position for Drive System Operation

Second-Generation Cart Position B



Figure 25: Second-Generation Cart Brake Lever Position for Manual Towing

Battery Bank Breaker

Turn the main battery breaker to the **On** position. (The breaker is located in the front belly compartment under the roll-up door).

- **Plug in your cart to charge weekly.** If the cart has been stored with the breaker (in the belly compartment) in the ON position without connection to AC power during that time, the cart battery bank may be too low to power on or to charge with the onboard system. Contact CoachComm Customer Support via 1.800.749.2761 for assistance if your batteries are too low to power your system.
- **Turn breaker OFF when traveling.** The battery bank breaker protects the cart's battery circuit from damage resulting from an overload or short. The breaker should be turned OFF when transporting the cart to away games and also if the cart is stored for more than one week without use. Be sure to leave yourself access to the belly compartment so you can turn on the breaker and activate the drive system to unload the cart.



Figure 26: Battery Breaker (On Position)

Drive System Switch

The drive system switch provides power to the drive system.

Turn the drive system switch to **On** position. (Switch located in the middle of the rear electronics rack.)

Note: The drive system will automatically power off after it is unused for 30 minutes. To restart the drive system, flip this switch off and back on.



Figure 27: Drive System Switch (On Position)

Handle Controls

The drive system handle contains several operational buttons. Ensure a tight grip on the handle when in operation.

- A. **Throttle:** Hold the throttle down (either forward or backward) to move the cart in that direction. When released, the cart will stop.
- B. **Emergency Stop:** When pressed or held, the emergency stop/reverse button provides an immediate halt and brief reversal in the event of a collision or other emergency.
- C. **Horn Button:** Use the Horn button to signal the sideline cart's movements for nearby vehicles and people.
- D. **Cart Tow Handle:** If the drive system is inoperable, and you must tow the cart behind a vehicle, extend the tow bar (on the outside of the handle) and secure it with the handle locking pin. Connect your tow vehicle to the provided hitch pin location.



CAUTION: SEVERE INJURY AND SYSTEM DAMAGE RISK:
 Never allow individuals to stand, sit, climb, or ride on any part of sideline cart to prevent injury. Be aware of all potential blind spots while driving the cart. Never drive on a slope greater than 15% or on wet/slippery slopes; reduced traction could result in loss of control of the cart. Never attempt to tow other items with the cart.

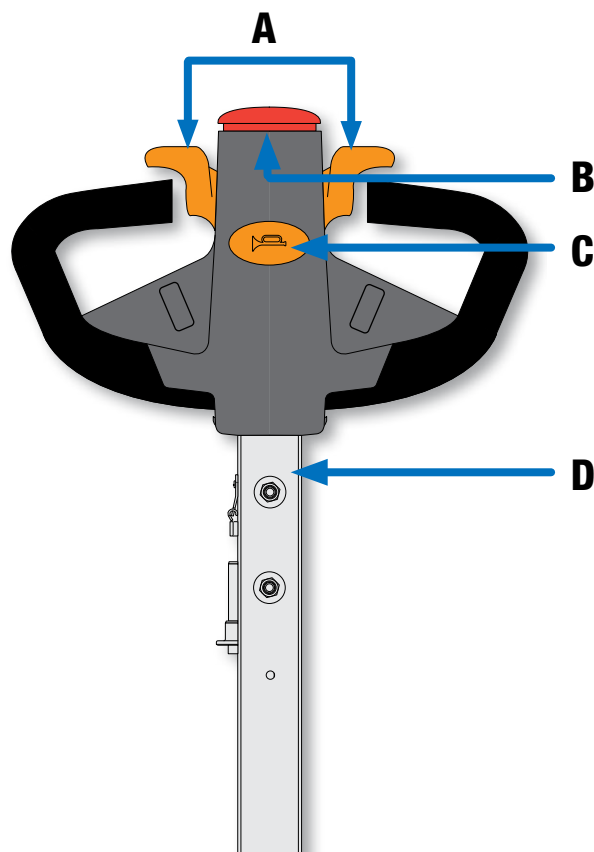

Figure 28: Drive Handle Controls

Wired Press Box Unit Overview

The Wired Press Box Unit is a trunk that is placed in the press box in or near the coach's box. It is the unit that will tie into the stadium "dry pair" and distribute the correct signal to each press box coach. At this time, no changes have been made to the functionality of the Press Box Unit; X-System connects to the existing Tempest NG Press Box Equipment, so users who are already familiar with its operation will have no change in their processes.

The Wired Press Box Unit houses a WAM 10 wired assignment module, a WIM 8 wired interface module, and an intercom power supply(s). Additionally, on the inside rear of the unit, connections are made for the dry pair via spring jacks or RJ-14s.

Wired Press Box Unit



Figure 29: Wired Press Box Unit Front View

- A. PS 4001 AudioCom® Power Supply(s)
- B. WIM 8
- C. WAM 10



WARNING – DANGER! Users should exercise extreme care when working with electricity. Additional care should be used when working with electricity outdoors in inclement weather. When working outdoors or near water, always connect the system into a ground-fault interrupting circuit.

Note: You can find Wireless Press Box Unit overviews in this document's Appendix A and B starting on page 107.

PS-4001 Power Supply(s)

Both the Press Box Unit and the Sideline Cart have integrated power supplies. These power supplies provide power for each intercom line. Two PS-4001s are used in 4-line systems (one each in press box and on sidelines) and four PS-4001s are used in an 8-line system (two each in press box and on sidelines).

On the inside of the Sideline Cart and the Press Box Unit the power supplies are attached to the WIM 8(RD). X-System operates optimally with both units plugged into AC power. If you do not have AC power available at both ends of your system, it is possible to operate the wired portion of the system with AC power connected to only one end of the system. In this mode, however, it is important to connect at least four (4) ground wires (two pair) between the sidelines and press box units.



Figure 30: PS-4001 Power Supply Overview

Wired Interface Module (WIM)

The WIM 8 (8 line) and WIM 8(RD) (ring down) are very similar. The WIM 8(RD) is the same as the WIM 8 but with the addition of integrated generators used for the ringdown circuits. Typically each X-System will have one WIM 8 (press box) and one WIM 8(RD) (sideline). The WIM 8(RD) provides the interface between the stadium wiring and the system. That interface is available via spring jacks or RJ-14s (4-wire RJ). The spring jacks are used for those instances when a user needs to attach to bare stadium wire. The RJ-14s are the preferred method since they provide plug and play connectivity.

In addition to connecting to the stadium wiring, the WIM 8(RD) connects to the WAM 10 and the AudioCom® power supplies. The WIM 8(RD) also provides connections for the local ringdown phone instrument, two flexible isolate/combine circuits, and a monitoring port. During run mode, the LCD will display line status, and during test mode, the LCD will show detected line faults.

Overview

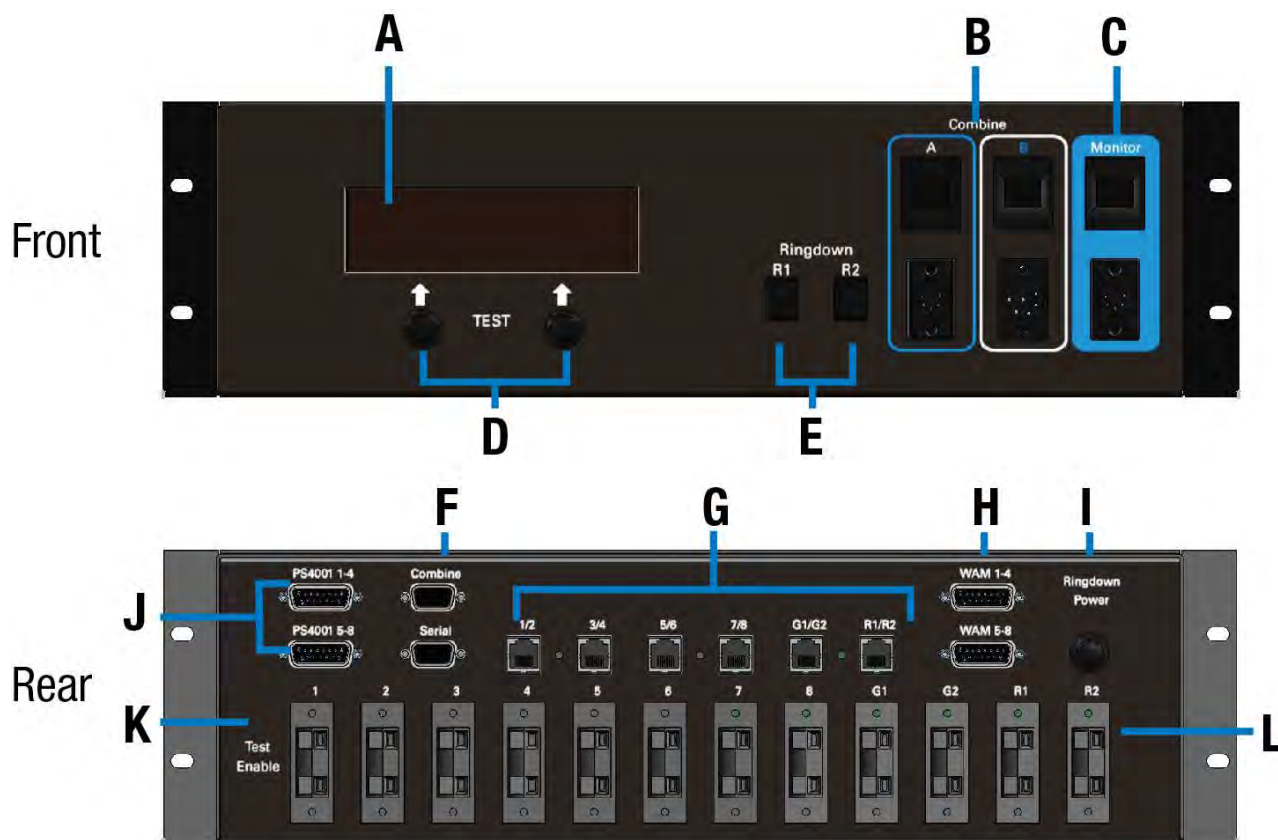

Figure 31: WIM 8 Overview

- A. LCD
- B. Flexible Combine Modules — FCM (2)
- C. Monitor Port
- D. User “soft buttons,” function indicated on LCD
- E. Ringdown instrument connections
- F. Remote trigger for Combine Circuits
- G. Dry pair connections, RJ-14s
- H. Connections to WAM 10
- I. Power entry for Ringdown Circuits (RD version only)
- J. Connections to local PS 4001 power supply(s)
- K. Test Enable Switch
- L. Dry pair connections, Spring Jacks

WIM 8 (RD) Integrated Dry Pair Tester (DPT)

The WIM 8(RD) also features an integrated dry pair tester (DPT). The DPT can only be used in systems where there are two WIM 8s.

When two WIM 8(RD)s are connected via dry pair, they can be put into “test mode.” In test mode, the WIM 8(RD)s will test each dry pair using Dual Tone Multi Frequency (DTMF) and display the results on the LCD screen. Both WIM 8s must be connected to the dry pair before testing can begin.

Note: The test mode should ONLY be used before the game. The DPT should NEVER be used during a game because in test mode, no communication over the dry pair is possible. However, there is a hard switch on the rear of the WIM 8(RD) that can defeat the DPT. If you wish to remove all possibility that the system will enter test mode during the game, that switch should be turned to the “Disable” position.

Note: AC power is required on both ends of the system for test mode. The WIM 8 will operate with limited functionality without local AC, but the DPT will not function.

You can start test mode from either WIM 8 in the system. To enter test mode, press the two user soft buttons under the LCD at the same time and hold them for approximately 5 seconds. The LCD screen will display the results of the tests and give options using the soft buttons.

The system will check each pair connected, whether through the RJs or Spring Jacks and report errors in continuity or crosstalk.

It is important to note that the two units communicate over the first four pairs of wires. If none of the first four pairs of wires are connected, the unit will exit test mode and report that no communication could be established with the DPT on the opposite end of the system. If any one of the first four pairs is connected to the remote WIM 8(RD) in any of the first four pair positions, the unit will enter test mode. At least one of those faults must be corrected before testing can be re-initiated as the two units must have at least one good pair to hand shake and begin testing.

WIM 8 (RD) Screens

- **Splash Screen** – This screen is displayed for a few seconds at power up of a WIM 8 or WIM 8(RD).
- **Default Operating Screen** – This screen is displayed during normal operation of the WIM 8(RD). The display shows all eight communication lines (1) and the status of both +24volt sides of those lines (2). A solid triangle indicates appropriate intercom power is present on a particular side of an intercom channel. If you have a 4-channel X-System, there will be no triangles showing under lines 5 through 8.
 - » To enter the “TEST MODE,” depress and hold the buttons (there are two) under the display directly below the words “Test” (3) for five seconds. The WIM 8(RD) has a test disable switch on the rear that makes it impossible for the unit to go into test mode. If that switch is in the “Disable” position, the display will alert you and revert back to the Default Operating Screen. If test is successfully initiated, you will see a status screen for approximately 1 minute, then the fault screen will display.



Figure 32: WIM 8 Default Operating Screen

- Dry Pair Testing Fault Screen** – This screen displays the faults found during the dry pair testing. If no faults are detected the screen will only show the header information with no detail line items listed below. The local pairs (1) are compared to the remote pairs (2) in a matrix. In Screen A (Figure 33), the system is showing that Pair 1 on the local unit corresponds to Pair 3 on the remote unit. Screen A also shows that Pair 2 locally is connected to Pair 4 on the remote side of the system. It also shows that lines 3 and 4 locally are connected to 1 and 2 on the remote end. If there are more than four lines of errors, the soft buttons will change to read “NEXT” and “PREV” as is appropriate. Use the buttons under PREV and NEXT to scroll through the results.



Figure 33: WIM 8 Dry Pair Testing Fault Screen

Flexible Combine Module (FCM)

Flexible Isolate/Combine Modules are not provided with X-System, but some customers may still have a Module from a Tempest NG system. This module allows for the combining or isolating of two intercom lines. For example, if you wish to have two lines of Offense (i.e., Offense 1 and Offense 2), you may wish for all coaches on the Offensive side of the ball to occasionally be in one conversation. A remote switch is provided on the end of a cable. The remote is plugged into the WIM 8(RD) in the appropriate 5 pin XLR jack. When the switch is activated, the corresponding lines of audio are connected and become one conversation.

There is a two digit thumbwheel per FCM. These are used to select the two lines that you wish to combine. While any two lines may be selected, you cannot repeat any line on both FCMs. For example, if FCM #1 is set to 1 2, then FCM #2 cannot be set to 2 3 since 2 is on both FCMs. This condition will create undesirable audio in the system.

Note: When any FCM is not in use, it should be set to 0 0 to maximize system performance. Also, the FCMs should be set to the desired settings prior to wireless set-up (covered later in this manual).

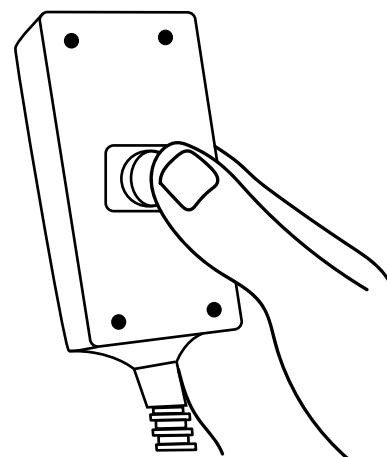
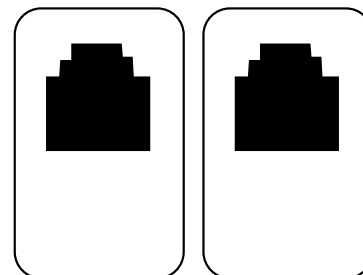

Figure 34: FCM Remote Switch

Ringdown Circuits

The Ringdown Circuits are two conventional telephone circuits completely separate from the intercom system. A customer-supplied telephone is plugged into the Ringdown Circuit in the Sideline Cart and another in the Press Box Unit. When one phone is taken “off hook,” the phone on the opposite side rings.

In X-System, the ringdown circuit generators are located in the Sideline Cart and are therefore on the AC power battery backup in the event of a power failure.



RINGDOWN

Figure 35: Rendering of Ringdown Circuits

Wired Assignment Module (WAM)

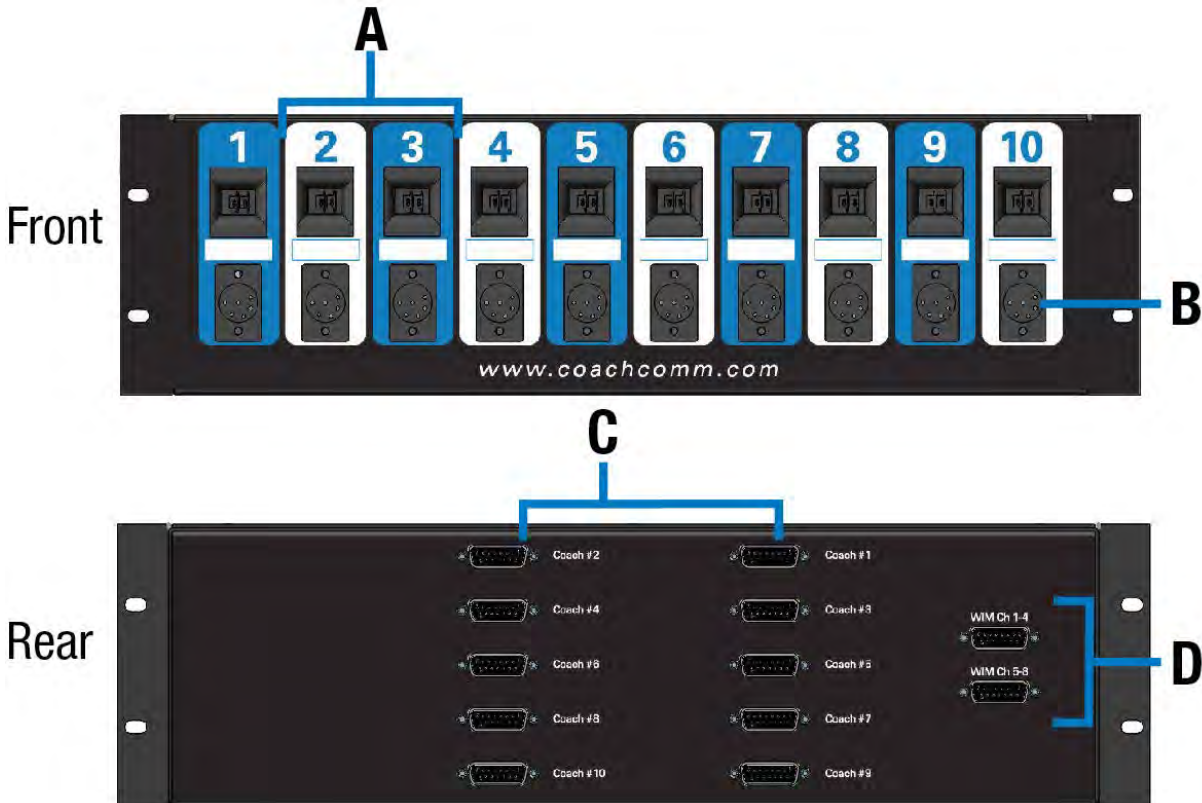

Figure 36: WAM 10 Overview

- A. Dual Assignment Thumbwheels (1 through 10)
- B. Wired back up ports, 6 pin XLR, two line (1 through 10)
- C. DA-15 connections for each assignment position (not used in Tempest NG or X-System)
- D. DA-15 connections to the WIM 8(RD)

The WAM 10 is the module that routes lines, or conversations, to the desired individuals on X-System. It connects to the intercom system through the WIM 8(RD) and from the WIM 8(RD) to the AudioCom® intercom power supplies and the stadium dry pair.

The WAM 10 is used to “patch” wired users to specific lines of intercom. The selectors or “thumbwheels” allow for selection of talk lines to be made for each user on the system. Each wired user is plugged into the XLR provided under that coach’s setting. Should a wireless coach require a wired unit during an outage or “back up” situation, a wired unit can be plugged into the XLR provided under that coaches setting. It should be noted, however, that the wireless system and the wired back up can be used at the same time.

The front of the WAM 10 has ten coach positions: 1 through 10. Each position has a two digit thumbwheel and a 6-pin XLR connector. For each coach, the thumbwheel is used to select which lines (conversations) that a coach will have access to. For example, if you have a coach that wants to communicate between lines one (1) and three (3), the left side of the thumbwheel for that coach would be set to “1,” while the right side of that coach’s thumbwheel would be set to “3.” If you have a coach that should only communicate on line four (4), both sides of that coach’s thumbwheel would be dialed to “4.” In this scenario, the coach can move the selector on the BeltPack, but the net result is that he remains on line four.

The WAM 10 routes the selected lines to the 6-pin XLR. The XLR is meant to be used in conjunction with a BP 2002 or BP 6000 with switchcraft neutrik adapter cable and a 6-pin, 2 line cable to provide wired backup for each coach.

For each wired coach, select the lines that coach needs to access via the thumbwheel switch and plug in a wired cable and BeltPack directly under that thumbwheel switch. If you have a problem with that coach's wireless component during the game or during setup, you may choose to put that coach on a wired set by simply plugging in a wired cable and BeltPack under that coach's selector switch.

Make a System Diagram — A very important part of successful system administration is to draw out a system diagram and document settings. There are many adjustments with X-System, especially if the wireless components are integrated into it. CoachComm strongly recommends that you spend the time to document your initial settings, so that in a rush you can get your system back in the same configuration time and time again.

If the coach is using a wired BP 1002 single-channel BeltPack, an adapter will be required. The adapter will be plugged into the 6-pin XLR under his respective thumbwheel, and that coach will have access only to the line shown on the left digit of that thumbwheel.

It is important to note that the XLR wired connections provided under each thumbwheel are not tied directly to the wireless system. The wireless system and wired BeltPack can be used at the same time independent of one another.

Sideline Cart Power Management

The block diagram below details the X-System Sideline Cart's power management and wiring.

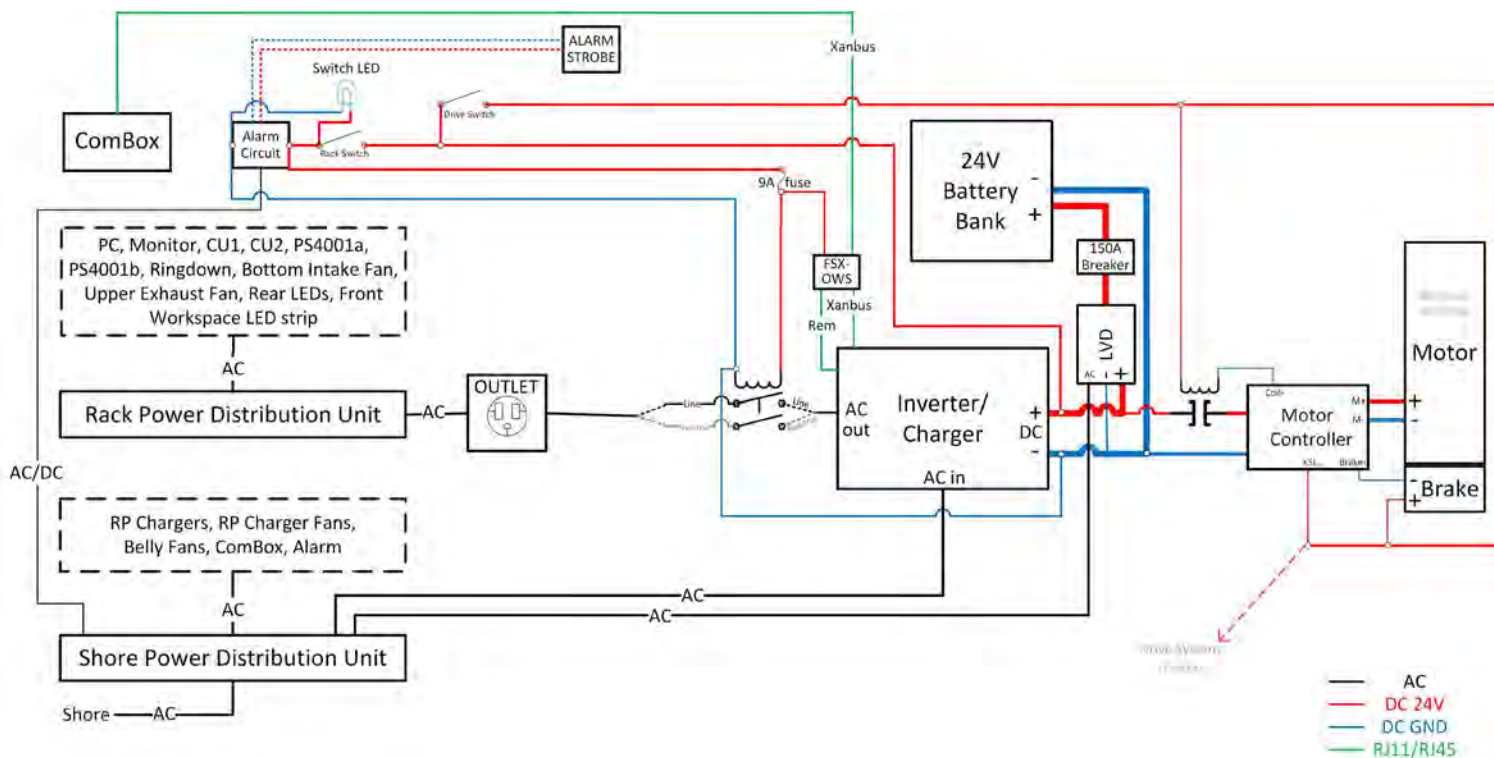

Figure 37: Sideline Cart Power Management Block Diagram

AC Power



WARNING – DANGER! Users should exercise extreme care when working with electricity. Additional care should be used when working with electricity outdoors in inclement weather. When working outdoors or near water, always connect the system into a ground-fault interrupting circuit.

AC Power Distribution Unit

By connecting the AC Power Distribution Unit to Stadium Power (or equivalent AC power source), the Power Distribution Unit provides AC power to the Inverter/Battery Bank, Power Bay fans, and the 5-bay RP battery charger(s) contained within the Sideline Cart.



CAUTION: The cart's AC power distribution unit's switch (located on the front rack, behind the acrylic door) must be in the RESET (ON) position for the cart battery bank to charge. CoachComm recommends leaving this switch in the ON position at all times.



Figure 38: AC Power Distribution Unit Switch

Inverter/Charger and Battery Bank

All AC power is distributed to the Sideline Cart through the AC inverter and battery bank. These devices back up the system in the event of a power failure. The inverter and batteries will keep the system operating for approximately 4 (or more) hours before running out of battery life.

Note: When operating in battery backup, the WIM cannot engage the DPT since both ends of the system must have power to operate in test mode.

During the 4+ hour backup power window, restore AC power from the stadium or prepare for wired-only operation. (AC power must be connected to the press box unit for the wired portion of the system to function with the absence of AC power on the sidelines.) In the event of a complete failure of AC on the sidelines (both from the stadium and depletion of the battery bank) the wireless portion of the system and the ringdowns will not function. The wired portion of the system will function with AC power on either or both ends, but not reliably.

Battery Bank Breaker

Plug in your cart to charge for a minimum of 8 hours after every use. This prevents the cart battery bank from being too low to power on or to charge with the onboard system. When the cart is not in use, you may store it in one of two ways: 1) with AC power connected (therefore maintaining battery bank charge using Float Charge Mode) or 2) with the battery bank breaker turned off.

If the cart has been stored with the breaker (located in the belly compartment) in the ON position without connection to AC power during that time, the batteries may be too low to power your system. Contact CoachComm Customer Support at 1.800.749.2761 for assistance if this occurs with your cart.

Turn breaker OFF when traveling. The battery bank breaker protects the cart's battery circuit from damage resulting from an overload or short. The breaker should be turned OFF when transporting the cart to away games. Allow enough space to access the belly compartment when storing or transporting so you can turn on the breaker and activate the drive system to unload the cart.

Inverter ComBox

The Sideline Cart's inverter ComBox manages communication from the inverter to X-Ware on the rack-mounted PC.

Inverter Alarm

This alarm sounds (and flashes) when AC power is lost and the AC inverter is activated. Once activated, the alarm can be disabled from the rear patch panel's Alarm Suspend button.



CAUTION: When the Inverter Alarm sounds, take action to identify the root cause for loss of AC power.

Rack Power

Rack Power Distribution Unit

The Rack Power Distribution Unit (mounted vertically to the rear of the racked components) supplies power to all of the rack equipment. It connects to AC Power via the Inverter, and in the event that AC power is lost, everything connected to the Rack Power Distribution Unit will continue operation with power provided by the battery backup system.

Master Power Switch

The Sideline Cart's Master Power Switch is located on the rear patch panel, and its functionality is described in detail in the next section.

Power Draw

During normal system operation, the sideline cart pulls around 4–6 A of power. You can see this on the screen on front of the AC Power Distribution Unit (bottom of the front rack). This number will spike to around 10–14 A when the cart's battery bank is being charged. As batteries charge, the amperage will decrease and return back to the normal range when fully charged.

Sideline Cart Rear Patch Panel

The Sideline Cart's rear patch contains the cart's Inverter controls, X-Net connections for RTs, SYNC IN port, and Stadium Dry Pair ports. See the details below about each connection on the panel.

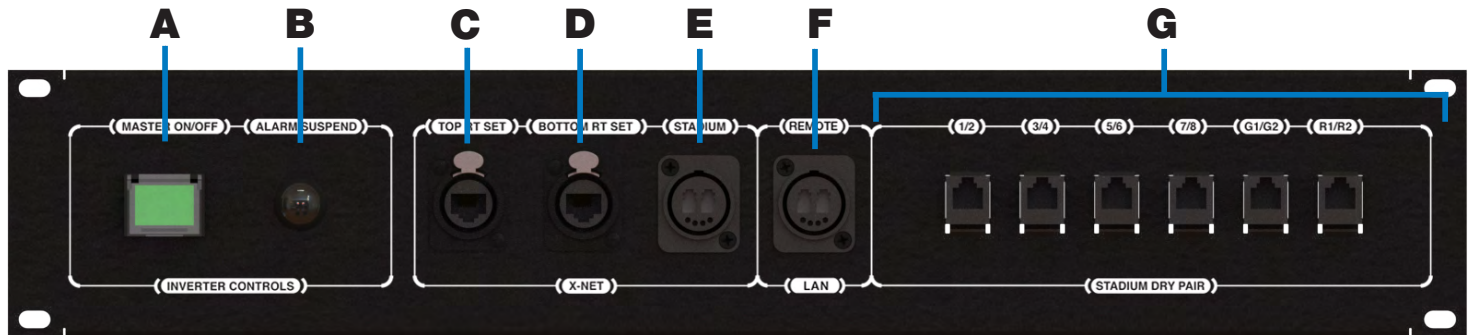

Figure 39: Sideline Cart Rear Patch Panel

- A. **MASTER ON/OFF:** Powers off Inverter and all downstream connections (including Rack power)
- B. **ALARM SUSPEND:** Silences the alarm that sounds when the Inverter's battery backup power is invoked (This alarm indicates that the AC power connection was lost.)
- C. **TOP RT SET:** RJ-45 Ethercon connection for the RT set mounted on the top of the mast
- D. **BOTTOM RT SET:** RJ-45 Ethercon connection for the RT set mounted on the bottom of the mast
- E. **STADIUM:** Duplex LC Neutrik OpticalCon Duo connection for the stadium single mode fiber cable (provides fiber X-Net connection from Sideline Cart to Wireless Press Box Unit)
- F. **REMOTE LAN:** Duplex LC Neutrik OpticalCon Duo connection for the stadium single mode fiber cable (provides fiber LAN connection from Sideline Cart to Wireless Press Box Unit)
- G. **STADIUM DRY PAIR:** Provides the interface between the copper dry pair stadium wiring and X-System via spring jacks or RJ-14s (4-wire RJ)

Control Unit (XCU-44)

The CoachComm X-System Control Unit (CU) is mounted in the front rack of the Sideline Cart. It serves as the foundation of the wireless communication system. The CU contains no radio and is frequency agnostic, which sets the groundwork for a multi-frequency capable system. For maximum flexibility, any CU can access, control, and monitor any active device across X-Net.

The CoachComm X-System Control Unit is the foundation for X-Net. A separate Radio Transceiver (RT) is required for RF communications. The Control Unit is capable of supporting all models of X-System Radio Transceivers at the same time (900MHz or 2.4GHz).

Control Unit Front

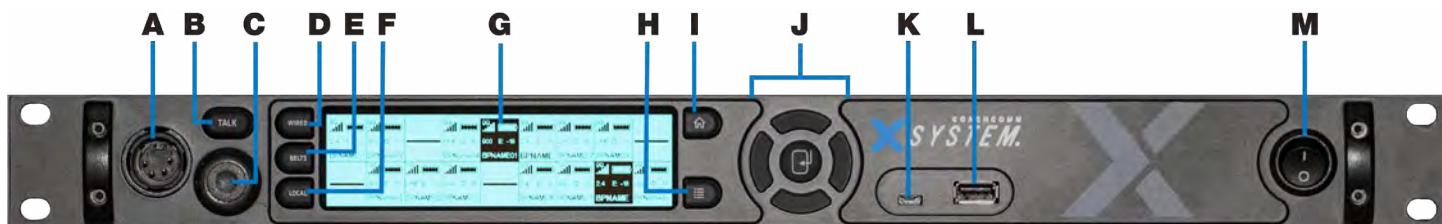

Figure 40: Control Unit Front View

- A. **Local Headset Connection:** 4-pin XLR male headset connector on the CU's front panel.
- B. **Talk Button for Local Headset:** The Talk button works in conjunction with the Local Headset Connection. The Talk button enables or disables the microphone for the local headset. A white "TALK" LED will illuminate when the mic is enabled.
- C. **Headset Volume Knob:** Turning the Volume control adjusts the listening volume of the local headset. Clockwise increases the audio level; Counter-clockwise decreases the audio level.
- D. **Wired Intercom Access Button:** When pressed, the Control Unit menu jumps directly to the Wired Settings screen.
- E. **Radio Packs Button:** Switches the Home screen to a selectable mode that allows selection of a (wireless) Radio Pack to edit its settings (via the navigational controls).
- F. **Local Button:** Opens the local headset settings on top of the current screen display, allowing for adjustments to the local headset settings.
- G. **LCD Screen:** Display for viewing real-time status of system, navigating menus, and making subsequent setting adjustments. The LCD screen is the focal point of the Control Unit's functionality. On the Home screen, the LCD displays the status of all Normal mode wireless Radio Packs that are currently paired to the Control Unit. High Density Mode RPs will not show on the CU LCD. In the Menu, the LCD shows the menu items or information.
- H. **Menu Button:** Accesses the main menu system of the Control Unit. While in the menu system, one short press acts as "Escape" to return you to the previous menu without saving any changes.
- I. **Home Button:** Returns you to the Home view when pressed. This also serves as an escape button; no changes that may have been in process are saved if Home is pressed before saving.
- J. **Navigational Controls:** Up, Down, Left, and Right move the cursor or marker on the LCD to make adjustments in edit mode. Enter (Center) selects the current cursor position or saves the current setting adjustment.
- K. **USB Micro B:** For connectivity to a computer.
- L. **USB A:** For Radio Pack pairing, additional X-System device connectivity to update firmware, and external USB flash drives.
- M. **On/Off Switch:** Turns the power to the Control Unit on and off.

Control Unit Rear

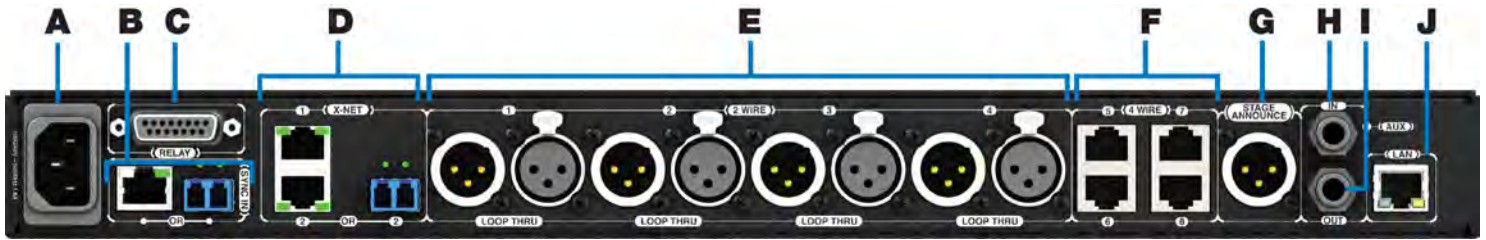

Figure 41: XCU-44 Back View

- A. **AC Power Connection:** 100–240V, 50/60 Hz 0.8A
- B. **SYNC IN Port (RJ-45 or Fiber):** SYNC IN allows the Control Unit to sync its timing with another external system to optimize both systems' performance, while keeping each system's audio separate and secure.
- C. **RELAY Connection:** Not currently used with X-System
- D. **X-NET Ports (Cat 5e or Fiber):** The Control Unit's X-Net ports allow it to connect to any available X-Net port on other devices, such as RTs, forming a proprietary network where all devices are part of a system configuration that shares data, timing synchronization, and audio. Each Control Unit has up to two X-Net connections, using either two RJ-45 ports (copper that is Cat 5e or greater) or one RJ-45 port and one duplex LC port (Single Mode Fiber).
- E. **2 WIRE Intercom Port (x 4):** The Intercom Channel ports (1, 2, 3, and 4) connect the Control Unit to wired intercom and dry pair wires. The pairs of XLR-3M and XLR-3F are electrically identical—including the grounds—and the grounds of the two channels are electrically isolated from each other. The 2-Wire Intercom settings can be adjusted under the Wired Settings menu or via X-Ware.
- F. **4 WIRE Intercom Port (x 4):** Not currently used with X-System
- G. **STAGE ANNOUNCE (SA):** Not currently used with X-System
- H. **Auxiliary Audio Input (AUX IN):** Not currently used with X-System
- I. **Auxiliary Audio Output (AUX OUT):** AUX OUT is used to supply intercom audio sources from the X-System Control Unit, used when recording audio out of X-System. The AUX OUT connector is a ¼" Tip/Ring/Sleeve jack.
- J. **Local Area Network (LAN) Port:** The LAN port allows the Control Unit to be connected to the system PC and X-Ware. The LAN port's LEDs indicate the status of the LAN link.

Understanding the Control Unit's LEDs

Each LED on the rear of the Control Unit indicates a particular condition or status for the device. See the table below for details about each meaning.

Port/LED	Description	
X-Net LEDs	Left	Green – X-Net connection is good
		Off – No X-Net connection detected
	Right	On (Green) – 1000 Mbps link is detected
		Blinking (Green) – Activity is detected
LAN LEDs	Left	Green – LAN link is connected
		Off – No LAN connection detected
	Right	Blinking (Amber) – LAN activity is detected
		Off – No LAN activity detected
Sync LEDs (Copper)	Left	Green – Sync connection is good
		Red – Sync connection has a problem (e.g., when an X-Net connection is made to the sync port of a non-primary CU).
		Off – No Sync connection detected
	Right	On (Green) – 1000 Mbps link is detected
Off – No Sync connection detected		
Sync LEDs (Fiber)	Left	Not used
	Right	Green – Sync connection is good
		Off – No Sync connection detected

Note: The left LED on the Sync In copper connection will be lit on the Primary CU only. All other non-primary CU Sync In LEDs will not be lit, indicating they do not accept a Sync (X-Net) Input.

Control Unit LCD

Home Operating Screen

Serves as the primary operating screen and displays the status of the Control Unit's connected Radio Packs.

Note: Currently, High Density-engaged RPs do not show on the front panel of any CUs. These packs can be seen in X-Ware.

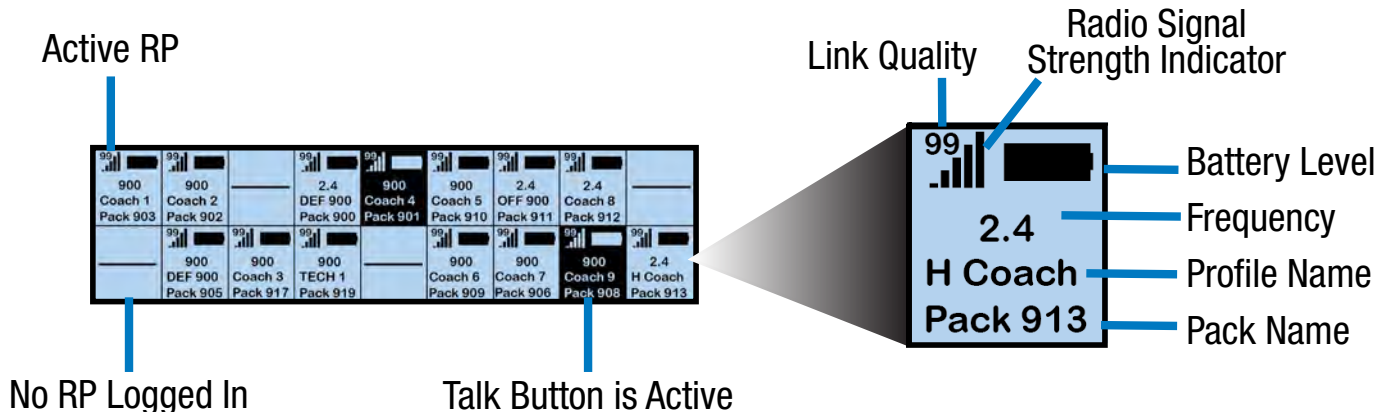

Figure 42: Control Unit Primary Operating Screen

Note: The Link Quality Indicator (LQ) provides a diagnostic measurement of actual packet transmission from Radio Pack to RT and vice versa. The LQ value on the Control Unit LCD represents the lowest LQ value of the two possibilities. To discover more about which value is displaying on your device, you would need to consult the individual Radio Pack or X-Ware. (See "Understanding Link Quality" on page 83 of this manual for more information.)

Secondary Operating Screen

Displays additional information about the status of the Control Unit's connected Radio Packs. Short press the Home button once to toggle between the Primary and Secondary screens. After 60 seconds, the screen will timeout and revert back to the Home screen.

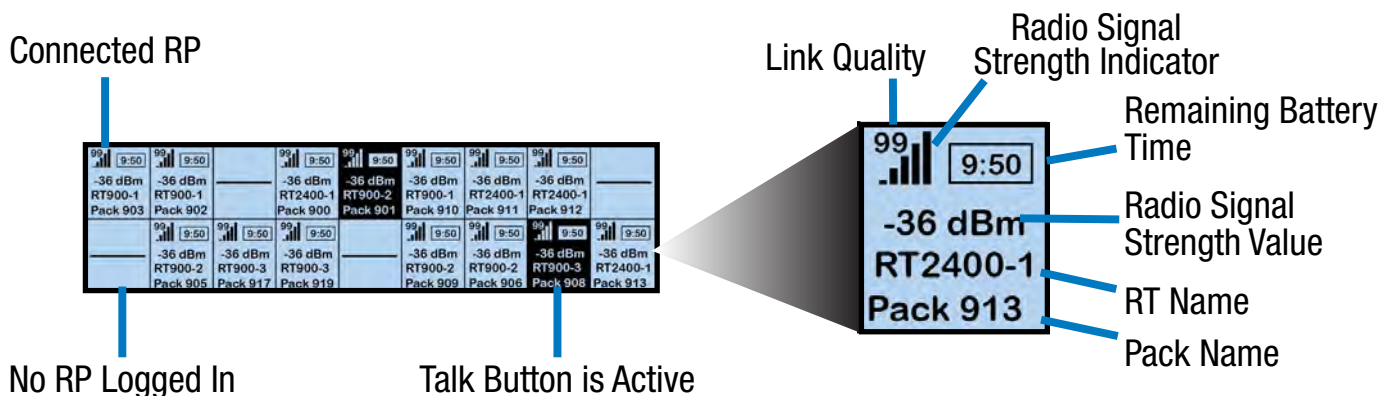
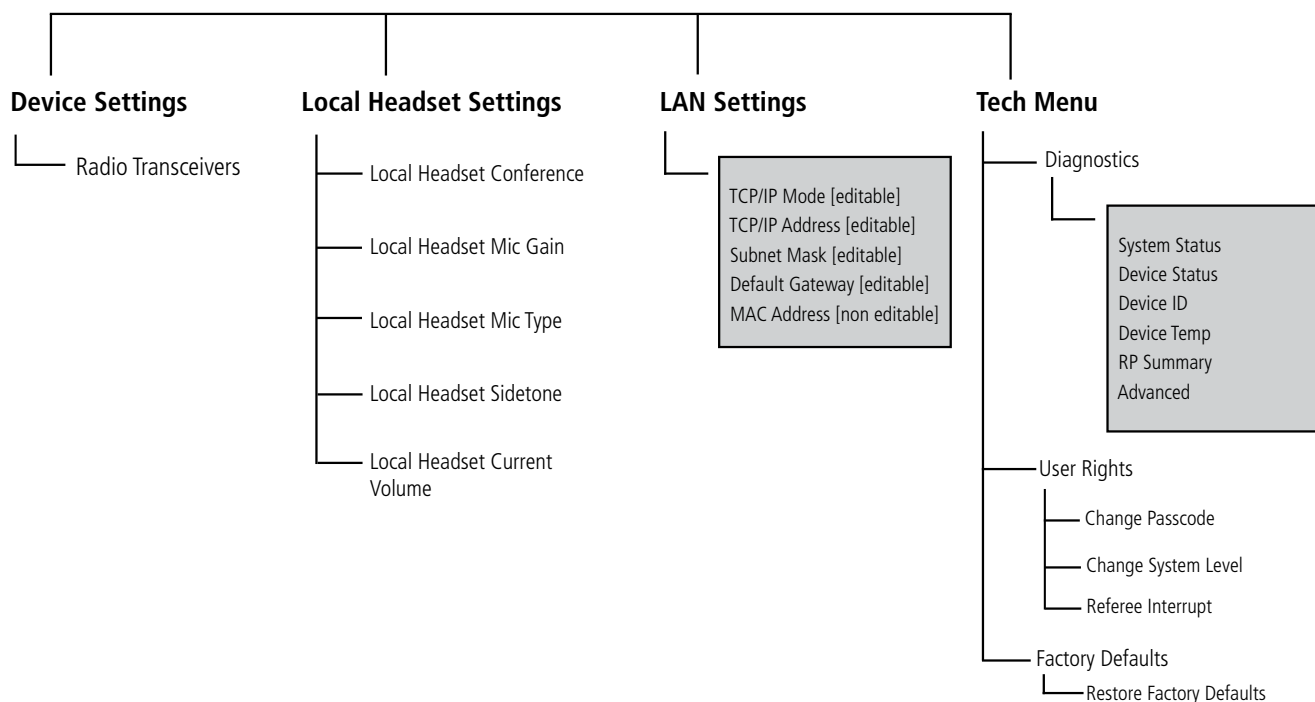
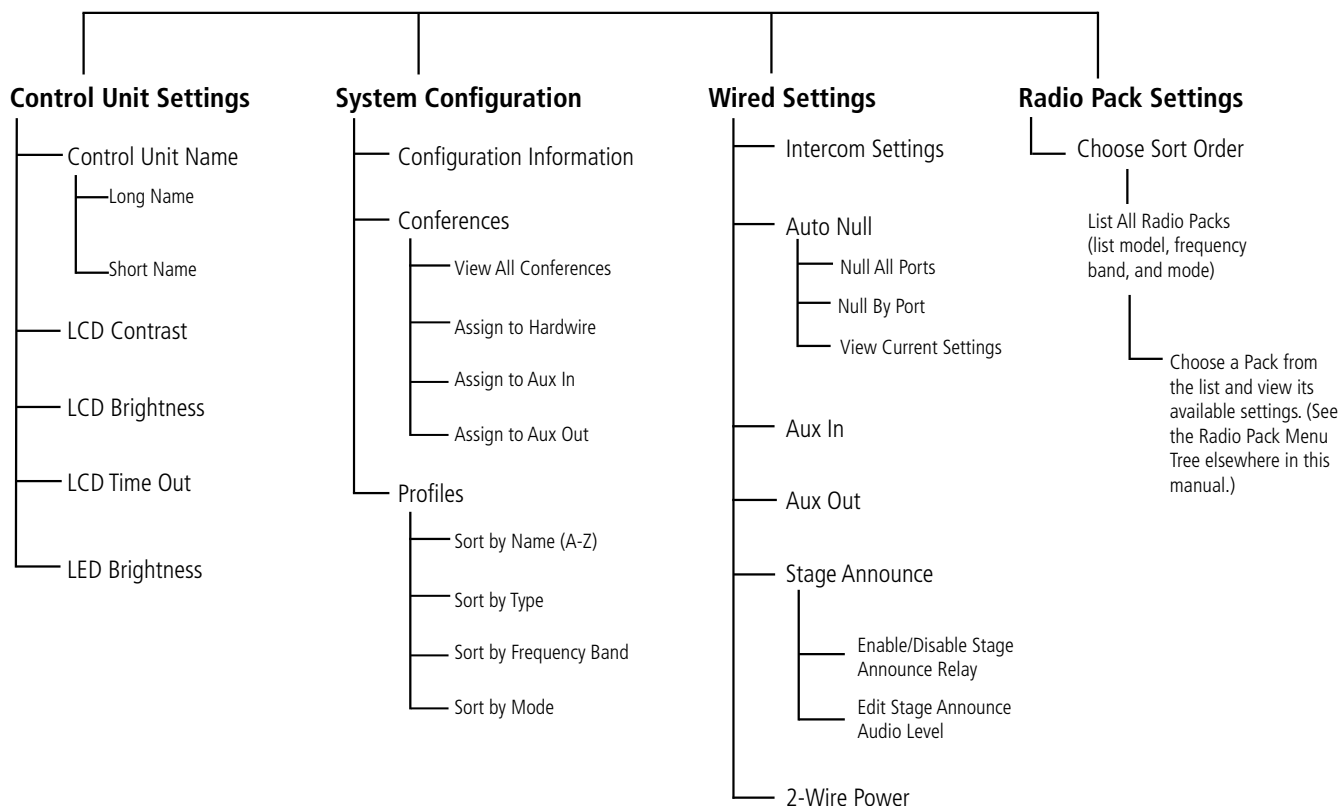

Figure 43: Control Unit Secondary Operating Screen

Note: Radio Signal Strength Value displays the actual value of the radio signal in dBm.

Control Unit Menu

The Control Unit settings can be accessed and adjusted from the Control Unit's front panel LCD, or via the X-Ware interface on the touch screen monitor. The following menu tree displays the Control Unit's primary menu options and settings.



Radio Transceivers (XRT-900, XRT-900-IPR, XRT-2400, and XRT-2400-IPR)

The X-System Radio Transceiver (RT) serves as a point of contact for wireless Radio Packs on X-Net and houses either a 900MHz or 2.4GHz radio. RTs should be positioned as high as possible on the Sideline Cart's mast to provide better and more expanded coverage. (See "RT Mast Assembly" on page 78 for more information about positioning RTs.)

For a single Control Unit to allow the maximum 18 Normal mode Radio Packs to communicate wirelessly (6 per RT), a minimum of 3 RTs is required.

RT Top

- A. **Antenna Connections:**
RP-TNC (Connector). Only CoachComm-approved antennas may be used with X-System RTs. For more information about antenna deployment see "RT Mast Assembly" on page 78.
- B. **PING LED:** Not currently used with X-System.

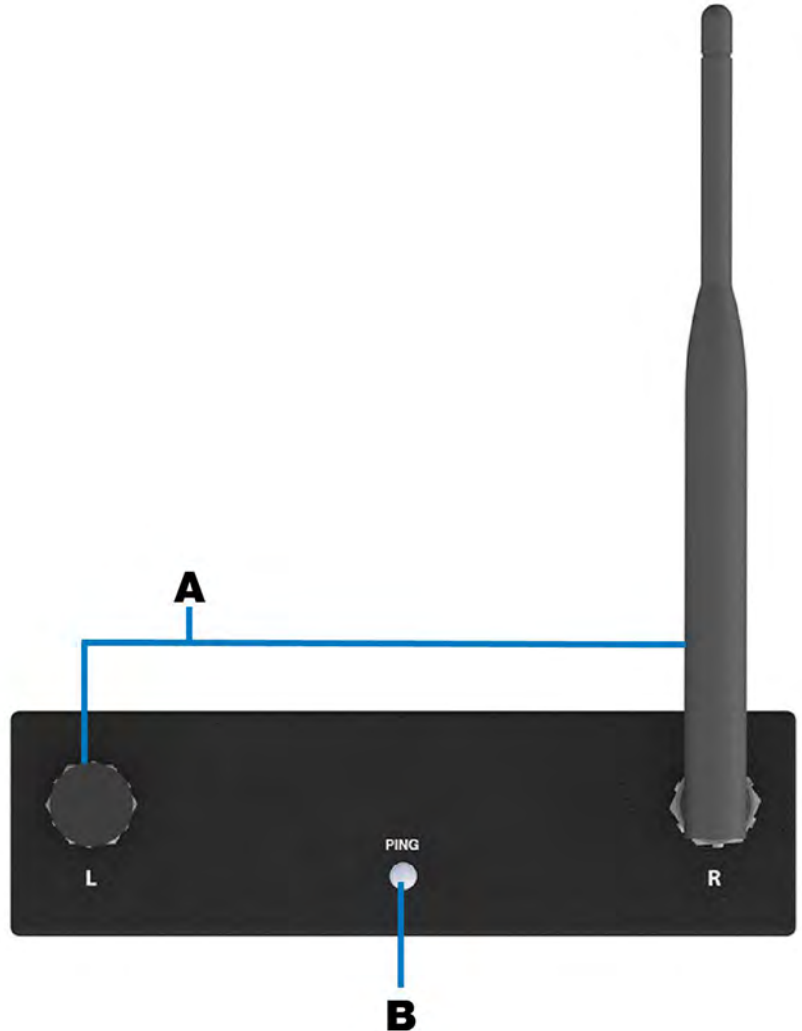

Figure 44: Radio Transceiver Top View

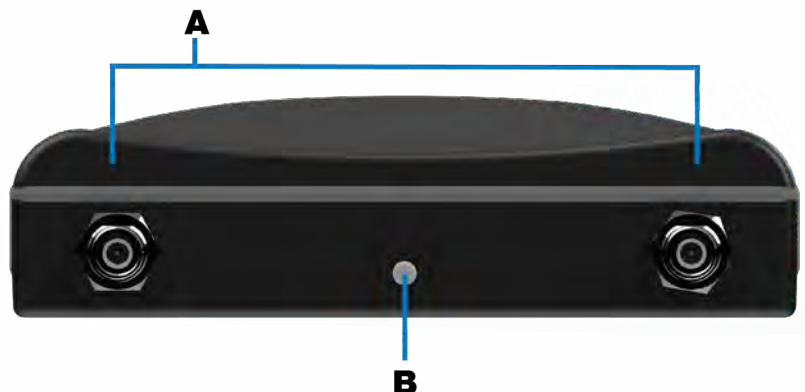

Figure 45: IP-Rated Radio Transceiver Top View

RT Bottom

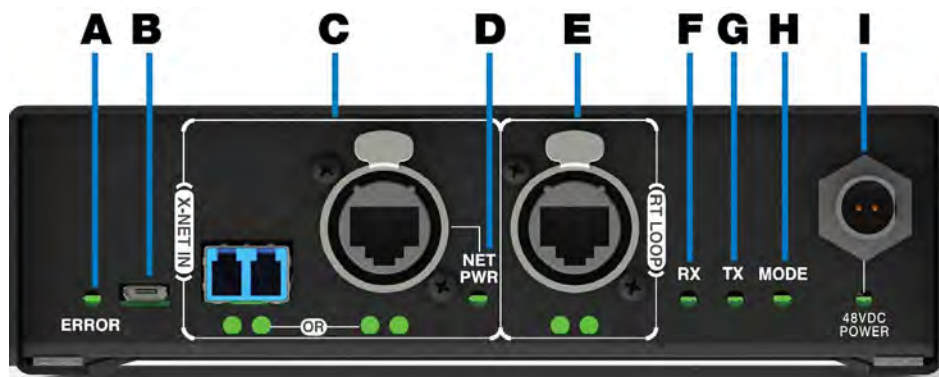

Figure 46: Radio Transceiver Bottom View

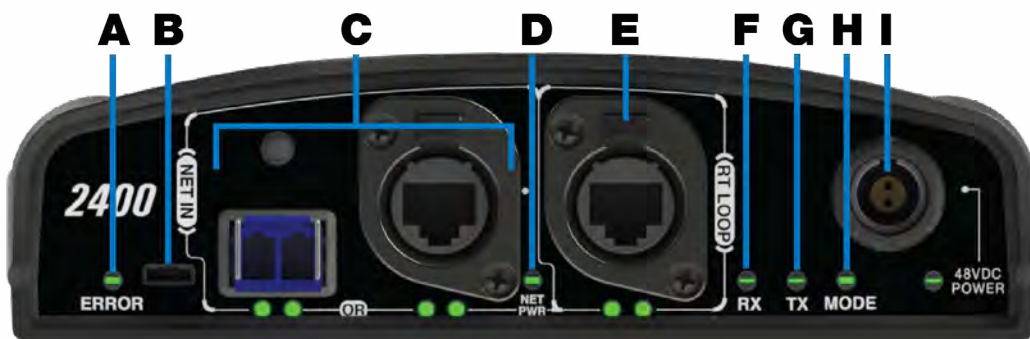

Figure 47: IP-Rated Radio Transceiver Bottom View

- A. **ERROR LED:** Indicates the device’s error status.
- B. **USB Micro B Connection:** For connectivity to a PC or Control Unit for updating device firmware.
- C. **X-NET IN Port (Cat 5e or Fiber):** The RT’s X-NET IN ports allow it to connect to any available X-Net port or RT Loop port on other devices, adding the RT to a proprietary network where all devices are part of a system configuration that shares data, timing synchronization, and audio. Each RT has an X-NET IN port (RJ-45 for Cat 5e copper or duplex LC for Single Mode Fiber) and an RT LOOP port (RJ-45, which allows RTs to be daisy-chained to one another).
- D. **Network Power (NET PWR) LED:** Indicates the presence and condition of network power, which is being provided to the unit via the X-NET IN port.
- E. **RT LOOP Port and Status LEDs:** The RT LOOP port allows you to connect multiple RTs together in a “daisy chain.” This port’s status LEDs indicate the status of the X-Net link.
- F. **RX LED:** Green LED—BLINKS when RT is receiving transmissions from Radio Packs.
- G. **TX LED:** Green LED—ON (blinking rapidly) when RT is transmitting properly.
- H. **MODE LED:** Green LED—ON when set to Normal Mode; Blue when set to High Density Mode; Blue (blinking) when operating in Standalone Mode.
- I. **48VDC POWER Connection and LED:** The locking DC Power Connector enables the RT to be powered locally with a CoachComm 48VDC power supply (sold separately). Only used in Standalone RT Mode (See “Appendix D: Standalone RT Mode” on page 141).

Radio Packs (XRP-13, XRP-22, and XRP-44)

The X-System Radio Pack (RP) is to be worn by a user on the sideline. This Radio Pack communicates directly to its corresponding RT. All wireless users are connected together through the wired system via the Control Unit and the WIM 8.

The X-System RP can be used with X-System in highly-varying applications and environments.



Figure 48: XRP-13

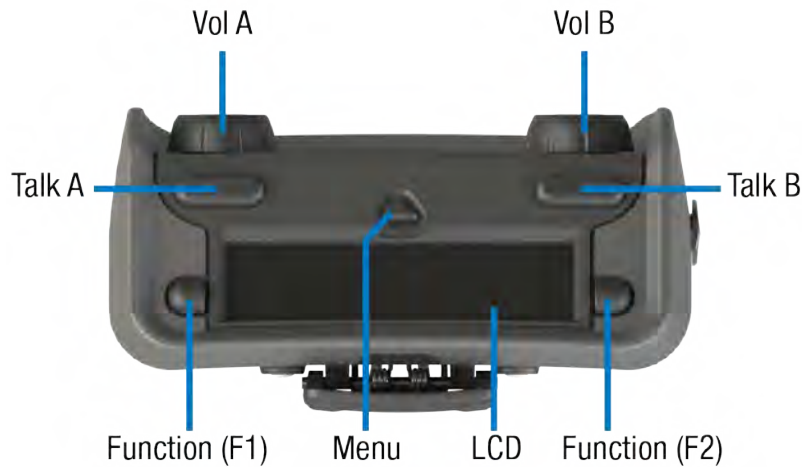

Figure 49: XRP-22

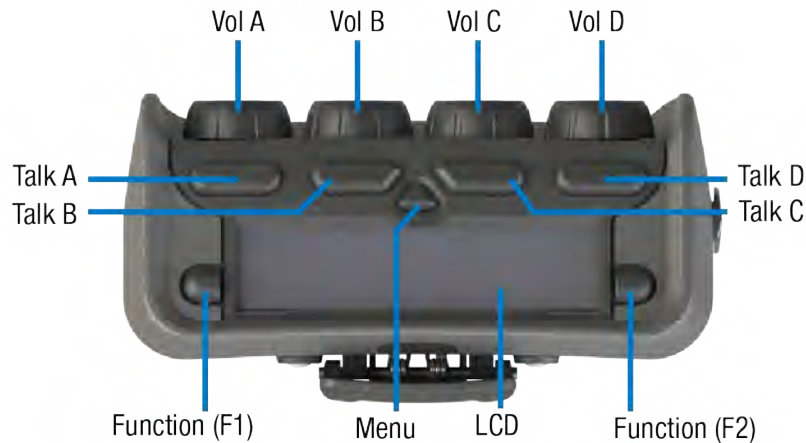

Figure 50: XRP-44

Radio Pack Top (All)

- **LCD:** Display for viewing real-time status of the RP, navigating menu options, and making subsequent setting adjustments.
- **Menu Button:** The Menu button provides multiple functions such as access to menu options or toggling between the home operating screen and the secondary operating screen.
 - » Short Press – Cycles the RP LCD from the Home Operating screen to the Secondary Operating screen and vice versa.
 - » Long Press – Accesses the menu options of the RP to view device/system information and make setting adjustments.
 - » Escape – While in the menu, one short press returns you to the previous menu without saving any changes.
- **Talk Button:** The Talk button enables or disables the microphone for the selected conference. Talk buttons can be set to function as “Latch” press, “Momentary” press, or “Always On.” In addition, X-System uses an intelligent latching method for Talk buttons. When set to “Latch,” one short press will latch the Talk on; however, pressing and holding the Talk button will cause the button to act as a momentary switch.
- **Function Buttons (F1/F2):** The left (F1) and right (F2) function buttons can be programmed to assign a variety of functions. Each Function button’s operation is set in the RP’s profile, which can be customized via X-Ware. While in the menu, one short press of F1 returns you to the previous menu without saving any changes.

Radio Pack Top (XRP-13 Only)

- **Conference A/B Rocker Knob:** The Conference A/B knob selects whether you are listening and talking to your RP Profile’s assigned Conference A or Conference B.
- **Conference C Button:** The Conference C button enables or disables the audio for the RP Profile’s assigned Conference C.
- **Volume Knob:** The Volume control adjusts the listening volume of the connected headset for the selected conference. Turning the Volume control clockwise increases the audio level, while turning the control counter-clockwise decreases the level.
 - » This control also serves as an Audio Overlay (AO) volume control when pressed and turned simultaneously. (AO must be enabled on Conference C first. See page 73 for more information about setting up AO.)

Radio Pack Top (XRP-22 and XRP-44 Only)

- **Volume Knobs:** Two volume knobs are available on the XRP-22 Radio Pack and four are available on XRP-44, and they are named from A to B and A to D, respectively, from left to right in X-Ware.

Radio Pack Rear

- **Belt Clip:** Secure and sturdy belt clip enables Radio Pack wearing via belt.
- **Battery Compartment Door:** Secures and protects the Radio Pack's Lithium-Polymer battery or 3 AA batteries.
- **Battery Door Latch/Magnet:** Secures the Radio Pack's battery door.
- **USB (Micro B) Connection:** This USB connection is

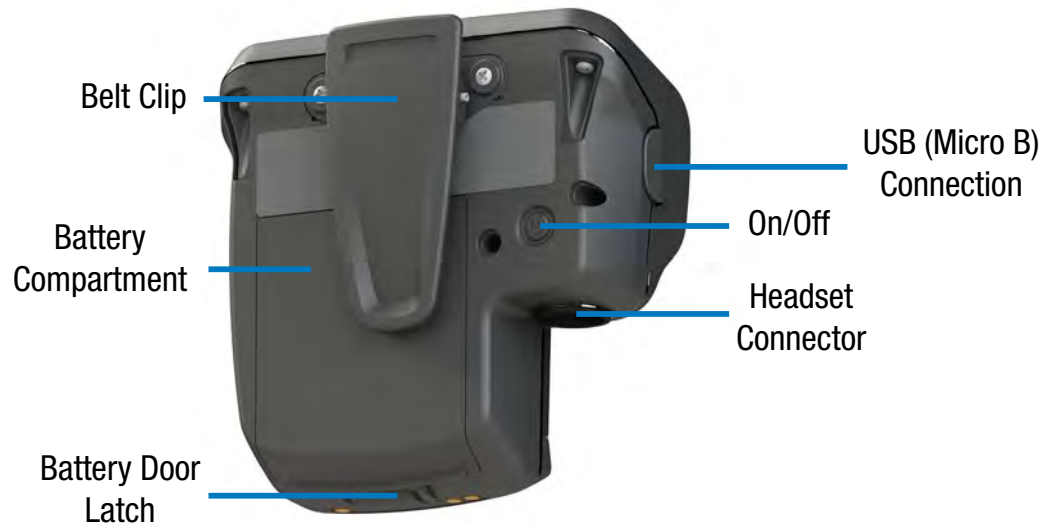

Figure 51: Radio Pack Rear View

- connecting a Radio Pack to a Control Unit for pairing and firmware updates. The Radio Pack may also be connected to a PC for firmware updates via X-Ware. See page 89 for more information on updating firmware.
- **On/Off Button:** The On/Off button powers the Radio Pack on and off when pressed for 3 seconds.
- **4-Pin Male XLR Headset Connector:** Headset connector is a 4-PIN male XLR connection. Optional XLR adapters (4-PIN female to 4-PIN female and 4-PIN female to 5-PIN female) are sold separately.

Radio Pack LCD

Home Operating Screen

Serves as the main operating screen and displays the status of the Radio Pack as well as talk, volume, and function assignments.

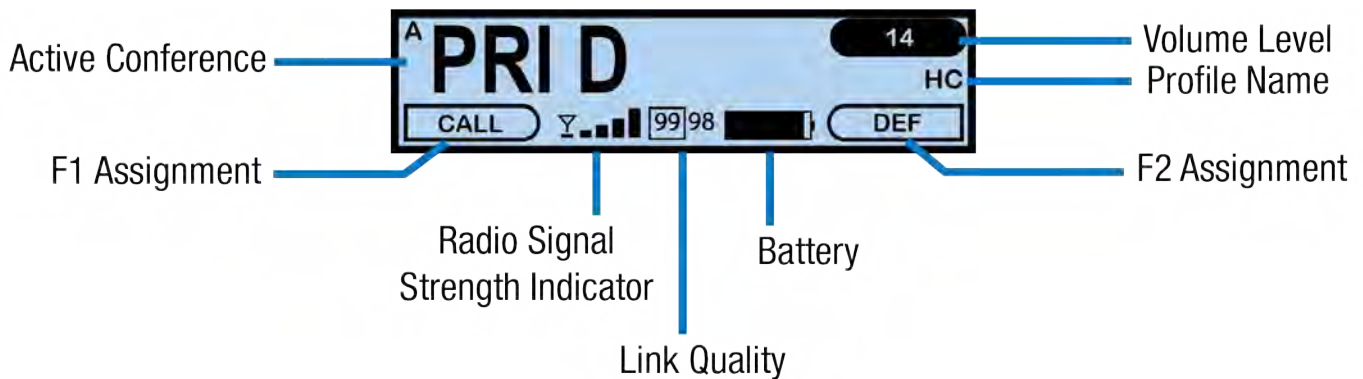

Figure 52: XRP-13 Home Operating Screen

Note: The Player Communication Mode (ISO, MIX, or SW) will replace the small A in the top left corner when the Function button is pressed on an active conference that includes X-System Players. Only XRP-13s support coach to player communications. XRP-22 and XRP-44 do not support coach to player communication using the function buttons, but the Talk buttons can be assigned to a player conference. The function button options below will not be available when the conference is assigned a Talk button.

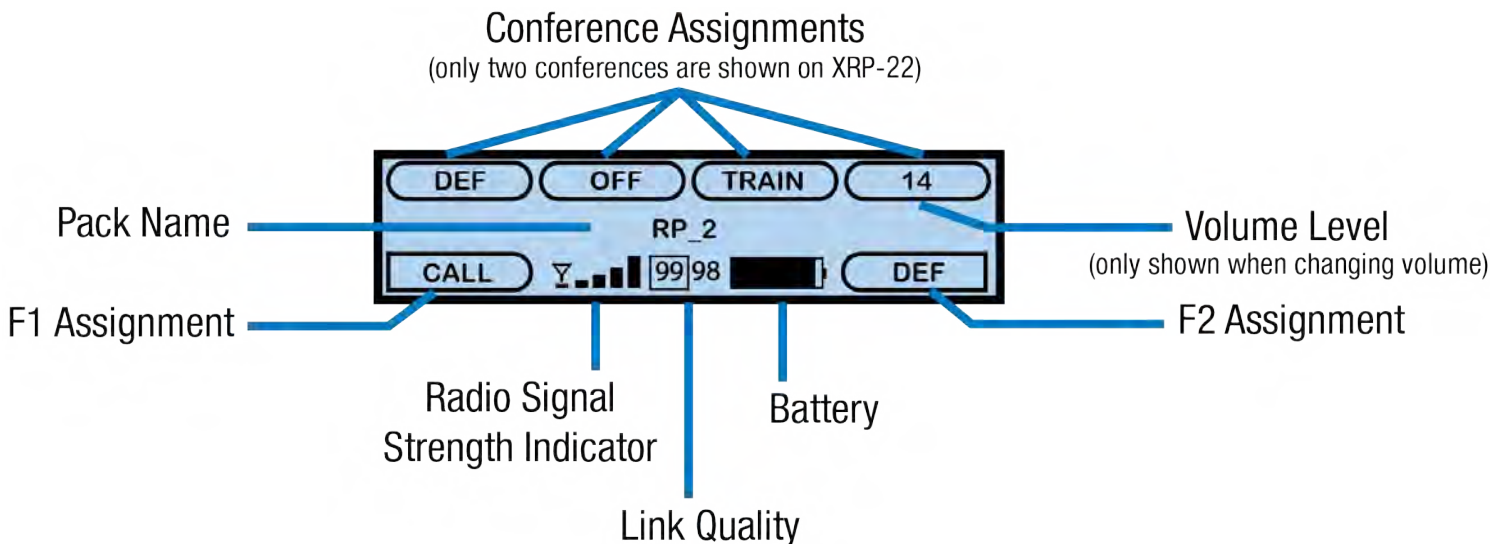

Figure 53: XRP-22 & XRP-44 Home Operating Screen

Note: The Link Quality Indicator (LQ) provides a diagnostic measurement of actual packet transmission from Radio Pack to RT and vice versa. The outlined LQ represents the Radio Transceiver's LQ. (See "Understanding Link Quality" on page 83 of this manual for more information.)

Secondary Operating Screen

Serves as a secondary operating screen and displays additional information about the status of the Radio Pack. Short press the Menu button once to toggle between the Home and Secondary screens. After 60 seconds, the screen will timeout and revert back to the Home screen.

Note: Radio Signal Strength Value displays the actual value of the radio signal in dBm.

Note: "RT" is replaced with "Practice" under RT Name when in Standalone RT Mode.

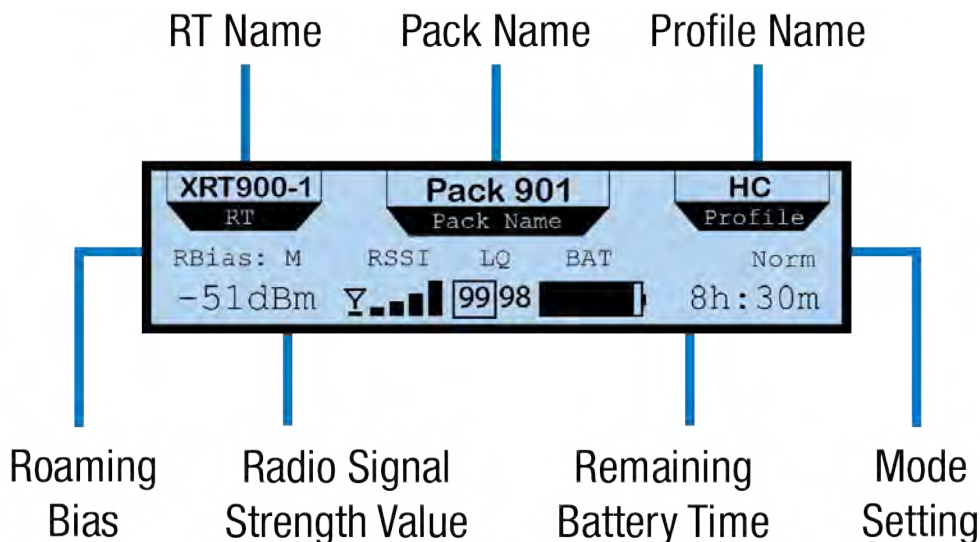
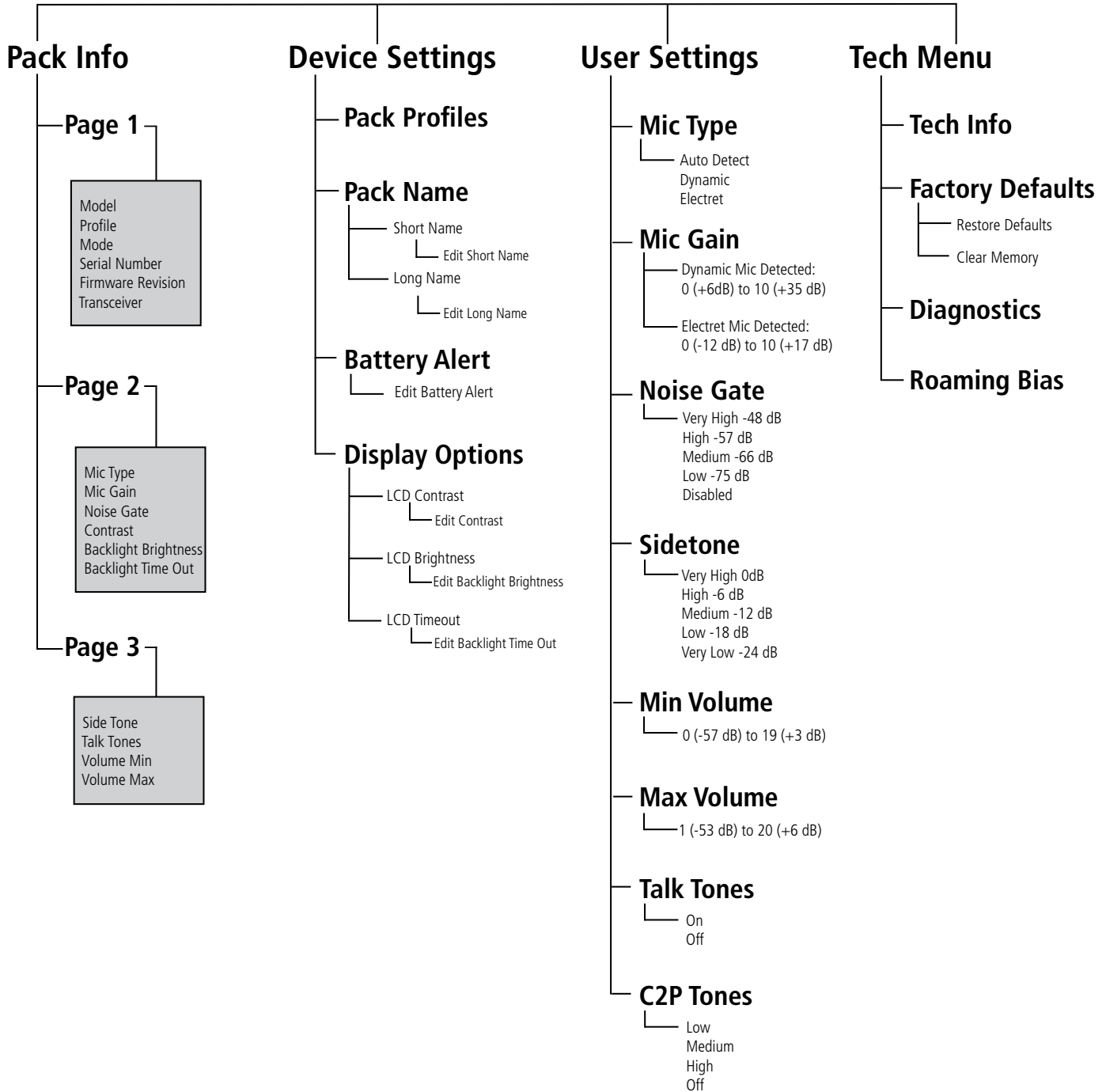

Figure 54: XRP Secondary Operating Screen

Radio Pack Menu

Radio Pack settings can be accessed and adjusted from the Radio Pack's LCD, the Control Unit's LCD, or via the X-Ware interface on the touch screen monitor. The following menu tree displays all of the Radio Pack's menu options and settings:



Radio Pack Battery System

Radio Packs are powered with one (1) Lithium-Polymer rechargeable battery for greater than 10 hours (2.4GHz) or 9 hours (900MHz), or they may be powered with (3) AA Alkaline batteries for approximately 5 hours (2.4GHz) or 4.5 hours (900MHz).

There are several considerations you should take into account when using AA batteries. The RP's battery level and remaining battery time indicators only reflect battery life for lithium-polymer batteries; therefore, those screen options will not be used when AA batteries are in use. In cold weather, AA batteries do not release their stored energy completely, so the result is a dramatic reduction in operation time. It would not be uncommon to have an AA battery only last 50% of its original life when used in very cold situations. Also, remove the AA batteries when not in use to avoid potential damage from leaking battery acid that can sometimes occur in these type batteries.

The battery can be charged in multiple ways.

Charge via RP Wall Charger

To charge the RP, connect the plug-in battery charger to a standard wall outlet and to the Micro-USB connector on the RP. The connector is located under the rubberized access cover on the side of the RP. The battery requires approximately three (3) hours to charge from empty.

Charge via USB Cable

The RP may also be charged by connecting the USB-A-to-Micro-B pairing cable to the USB port of a PC and to the Micro-USB connector on the RP. The connector is located under the rubberized access cover on the side of the RP. The battery requires approximately three (3) hours to charge from empty.

Charge via 5-Bay Battery Charger

The 5-Bay Battery Charger charges up to five (5) CoachComm lithium-polymer batteries at the same time. The battery requires approximately 3 hours to charge from empty. This charger may be located in the rack of the Sideline Cart.

If charger(s) overheat, it will need to be moved to a cooler area to charge batteries properly. As a lithium-polymer battery safety mechanism, the battery chargers include a safety circuit, which prevents charging of batteries if the ambient temperature is too hot. It is important to note that the chargers do NOT run from the battery bank inside the sideline cart. For the batteries to charge in the 5-bay charger, the Sideline Cart must have external AC power.



Figure 55: 5-Bay Battery Chargers

Charge via 6+6 Drop-In RP and Battery Charger

The CoachComm 6+6 Drop-In RP and Battery Charger charges up to six (6) batteries in the Radio Packs and up to six (6) stand-alone batteries. Batteries inside RPs require approximately 4 hours to charge from empty; batteries alone require approximately 2.5 hours to charge from empty.

This charger may be located in the rack of the Sideline Cart or in the shelf of the Wireless Press Box Unit. (See Appendix A and B starting on page 107 for more information on the Wireless Press Box Unit.)

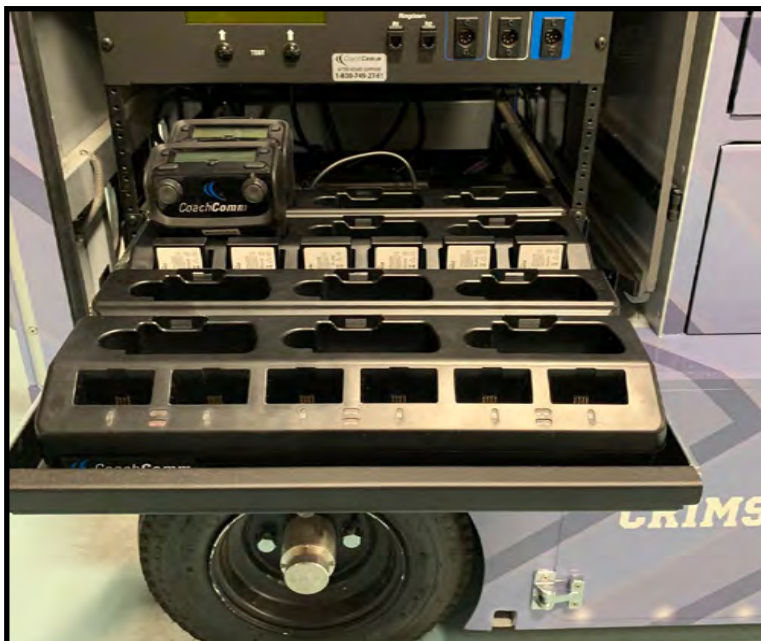

Figure 56: 6+6 Drop-In RP and Battery Chargers

If charger(s) overheat, it will need to be moved to a cooler area to charge batteries properly. As a lithium-polymer battery safety mechanism, the chargers will disable charging if batteries are too hot (over 113°F). It is important to note that the chargers do NOT run from the battery bank inside the sideline cart. For the RPs and batteries to charge in the 6+6 Drop-In Charger, the Sideline Cart must have external AC power.

Installing a Radio Pack Battery

Before powering on an RP, install its battery by doing the following:

1. Hold the RP at a 45-degree angle, pointing the bottom end down. Then, depress and hold the RP's belt clip down.
2. Lift open the battery door and remove it.
3. While still holding the RP at an 45-degree angle and depressing the belt clip, install a fully charged Lithium-Polymer rechargeable battery or three AA batteries in the RP. Take care to insert the battery with the contacts facing down into the RP and oriented such that the contacts on the battery will line up with the contacts inside the RP battery compartment.

- Place the battery door back on the RP, making sure to align and insert its tab at the top first, and then secure the door by pressing until it clicks. (Secure a magnetic door by pressing firmly until the magnet engages.)



Figure 57: Rear View of RP's Power Button and Battery Door



Figure 58: Radio Pack Battery Installation

- Turn on the RP by pressing and holding the Power button on the back of the pack for 3 seconds.

Note: The RP will not operate unless it has been paired to a Control Unit; if it has not been paired it will indicate “No Pairing Information Available” on the pack’s display. In addition, the RP will not communicate if its CU And RTs are not yet online. CoachComm recommends powering on the CUs and RTs before powering on the RPs.

Pairing an RP to a Control Unit

RPs must be paired to a Control Unit (CU) before they can operate with your X-System. Once RPs are paired to a CU, this process does not need to be done again unless the RP is being paired to a new or different CU (for example, after a replacement is made for repairs). An RP may be paired without installing a battery, if required. In this case, the CU will provide power to the RP during the pairing process. If no battery is installed, the RP will power down as soon as it is disconnected from the CU.

- Compatibility Note:** To work together as a system, all connected devices must have firmware that matches the version installed on the top CU. See “Updating Device Firmware” on page 89 for more information.
- Limit of Active RPs for systems with more than three Radio Transceivers (RTs):** A maximum of 18 900MHz and 18 2.4GHz RPs may be active on X-System because each RT allows 6 RPs. Since only 18 RPs can be active on a single CU, you should pair 900MHz RPs to the top CU, and pair 2.4GHz RPs to the bottom CU. If you have more than 18 RPs in either frequency, you can pair the extras to the appropriate CU, but those extras will not display as “active” until you remove one of the original 18 active RPs.

To pair your RP, use the following steps. **IMPORTANT:** While pairing, do not disconnect the RP until you are instructed to do so.

- Connect the RTs (on the mounting bracket) to the sideline cart’s rear patch panel. Then, power on the CU(s).

- When prompted on the top CU, select either **Home** or **Away**. Wait about 2 minutes for the configuration file to load on the system—all CUs will display a “CCF Loaded” message and a configuration file summary—wait until this message has cleared from all screens before taking further action. Once the message times out, the home screen will display on the front of the CUs.

CCF Loaded			
Version: 3	Flags: 02	Length: 21,232	Number of Devices: 8
Device Connection: 7	Control Unit: 2	Expansion: 0	Hub: 0
Radio Transceiver: 6	Radio Pack: 36	Radio Pack Profile: 36	
Conference: 12	Relay Assignment: 0	Aux Audio Assignment: 0	
User Info Record: 0	Access Rights: 0	UI Data: 0	

Figure 59: CCF Loaded Screen

IMPORTANT: If your system supports both 900MHz and 2.4GHz devices, you should pair 900MHz RPs to the top CU and pair 2.4GHz RPs to the bottom CU, since only 18 RPs can be active on a single CU.

- Connect a USB-to-Micro-USB cable from the top CU to the device (micro end goes into the RP’s USB port beneath its rubber port cover). The RP will power on by itself. Pairing begins automatically and should take about 30 seconds.

Note: If the RP you are pairing has the dual pairing feature enabled (from the RP’s menu choose **Device Settings** then **Pairing**), the new CU pairing will be added to the list of available CUs for that RP, and the new CU will become the active pairing. If the RP already has already been paired to two CUs, pairing to a third CU will override and replace the non-active pairing. The new CU will become the active pairing; the previous active pairing would still be available in the list of dual pairings.

- When prompted, use the RP volume knob and function buttons to choose a Profile from those available in the list on the RP’s LCD.
- Wait for the Profile to load. The LCD will display a “Pairing Complete” message when the profile is finished loading.
- Disconnect the USB cable from the device. The RP will power down automatically when disconnected.
- Power on the RP and wait for it to log in to the system. The initial login may take up to 90 seconds. When an RP is logged in, its RSSI indicator will display on the primary LCD screen.
- Verify that the RP paired correctly and is displayed on the CU LCD and in X-Ware. You may need to refresh the X-Ware display by touching the grid button on the right-hand side (See Figure 60).



Figure 60: X-Ware Grid Button

NOTE: If you’re using a new or recently serviced CU, or if you are pairing an RP that has never been paired to your system, the RP icon(s) in X-Ware will default to the top left corner of the software Home screen. Position the icon(s) as desired for your configuration.

- The RP is ready for use. Repeat steps 4–9 until every RP is paired.

Tip: RPs with dual pairing can switch the active pairing between CUs with this shortcut: Hold down both Function buttons for 5 seconds.

View CU Pairings

The list of paired RPs can be found in the CU and in X-Ware’s Advanced Settings. In the CU menu > Radio Pack Settings, select a sort option to view the paired RPs. In X-Ware’s Advanced Setting under the Device Management tab, the paired RPs list can be found to the right of the Control Unit port information.

System Accessories

Wired BeltPacks

(AudioCom® by Telex®)



Figure 61: BP 1002, BP 2002, and BP 6000 Wired BeltPacks

Each wired user on the system must have either a BP 1002 single-line or BP 2002/BP 6000 dual-line BeltPack. Connections on the BeltPacks include a 4-pin headset connector and a 3-pin (BP 1002) or 6-Pin (BP 2002 or BP 6000) XLR for connection to the system. For a BP 1002 to work with a WAM 10, you will have to purchase a 6-pin-to-3-pin adapter since the WAM 10 only supports 6-pin equipment. The BP 6000 comes with the switchcraft neutrik adapter cable. The neutrik adapter cable will connect to the existing field and press box cables.

The BeltPacks feature a large volume control and a “Talk” button. This talk button must be activated before that user is heard on the system. Additionally, the BP 2002 and BP 6000 feature a “line” button that allows you to “toggle” back and forth between two different conversations (or lines) on the system.

Field and Press Box Cables



Figure 62: Field and Press Box Cables

Wired users are connected to the Sideline Cart and the Press Box Unit via Field and Press Box cables. Field cables are generally 100 ft. in length. They can be customized to 125 ft. or 150 ft. Press Box cables are generally 25 ft. in length. There are two variations of each cable: single line and dual line. The single-line cables (ME 100HD and ME 25HD) are used in conjunction with the BP 1002 single-line BeltPack for those users who are to have direct access to only one line. (See exception in the Flexible Combine Module (FCM) section on page 27.) The dual-line cables (ME 100/2HD and ME 25/2HD) are used in conjunction with the BP 2002 or BP 6000 dual-line BeltPack for those users who are to have direct access to two lines.

Headsets

Previous models sold are the PH-100 and PH-200, the HR-1 and HR-2, and the SM-100 and SM-200. CoachComm now offers exclusively the SmartBoom[®] series of headsets (SBP-191 and SBP-192). The SmartBoom technology enables you to effortlessly mute your microphone by simply raising the boom above your brow. Re-enable the microphone by lowering back to the mouth. All headsets have a 4-pin XLR connector.



Figure 63: Dual-Ear Model SmartBoom PRO Headset



Figure 64: Single-Ear Model SmartBoom PRO Headset

System Configuration File

X-System's System Configuration File contains everything about a system, including X-Net device locations, port assignments, conferences, and profiles. This file lives in the Control Unit, and it coordinates all device activity on the system. Only one configuration file can be live on a system at any given time; however, you can save multiple versions of configuration files locally or on a USB drive. These saved files have a ".ccf" file extension, which stands for "CoachComm Configuration File." CCFs can be edited offline using X-Ware on your PC and then uploaded to the top Control Unit directly from X-Ware or via a portable USB drive at the front USB port of the CU. Instructions for Uploading a CCF are provided in the following sections.

Each X-System is pre-configured by CoachComm with the customer's desired settings, and setup/modification of the configuration file is performed from X-Ware. CoachComm's customer support staff is available to help with any advanced configuration needs during the season.

Saving a System Configuration File

Changes to the configuration during operation will be saved at the Control Unit. However, if you wish to save a copy of the configuration file for later use, follow these procedures:

1. Make sure your Control Units are powered on. If you have not already done so, set the Home/Away status.
2. Launch X-Ware, then click the gear icon located at the top right of the home screen. This will launch X-Ware's Advanced Settings window. (See page 55 of this manual for more information about using X-Ware.)
3. If you wish to save your file to a USB Drive, insert one into the X-System computer (located in the top, rear rack area behind the touch screen monitor.)

Note: Make sure the USB drive has enough space on it to save the file. 50 KB should be plenty.

4. Go to **File** and click **Save File As...** and save your file to your USB drive or to a designated folder on your cart computer.

Note: The file name must be 8 characters or less! It is helpful to include your school and a date in the name when sending it to CoachComm for assistance. For example, AU_W9_18, TAMU8.30, etc.

Note: The X-System CU is currently compatible with FAT and FAT32 formatted USB thumb drives (up to 16 TB drive size). Some operating systems (e.g., Windows 10) promote NTFS format, but only allow FAT32 formatting up to 32 GB. For help with formatting larger USB thumb drives, contact CoachComm Customer Support at 1.800.749.2761.

5. Once the file has been saved, you can exit out of the software and eject your USB drive from the computer.

See "Uploading a Configuration File" on page 52 for instructions on uploading a saved file to your system. See "Opening a System Configuration File Offline" on page 67 for instructions on how to work with a saved configuration file.

Uploading a Configuration File

Uploading a Configuration File via X-Ware

Follow these procedures when uploading a previously saved configuration file to your system via X-Ware. See "Opening a System Configuration File Offline" on page 67 for instructions on how to work with a saved configuration file.

1. Connect your RTs, make sure each Control Unit (CU) is powered on and has completed loading the current configuration file, select Home or Away, and open X-Ware. The system will be "Live" using the CU's current configuration file.

2. Open X-Ware Advanced Settings window by tapping on the Gears icon.
3. Save a backup copy of the current configuration file by selecting **Save File As...** from the File menu. A Windows directory will display where you can choose a file location and name for the saved backup file.

Important: Saving a backup copy of the current configuration file is helpful in case you need to revert back to it for any reason.
4. Select **Upload File...** from the File menu.
5. Follow the X-Ware prompts to complete the upload. While uploading, X-Ware will notify you of any configuration exceptions (for example, any RPs needing to be repaired).
6. During the upload, X-Ware will disconnect.
7. Acknowledge all X-Ware prompts, then reboot your X-System CUs when prompted by the CU LCD. Once rebooted, X-Ware will reconnect.

Loading a System Configuration File via USB Drive

Follow these procedures when uploading a previously saved configuration file to your system via USB Drive. See “Opening a System Configuration File Offline” on page 67 for instructions on how to work with a saved configuration file.

Important! Be sure you have saved a backup copy of your current configuration file prior loading a new one, in case you need to revert back to it for any reason.

1. Make sure each Control Unit (CU) is powered on and has completed loading the current configuration file, then plug the USB drive into the front of the top CU. An External USB Drive menu screen will display on the CU LCD.
2. Use the CU’s navigation buttons to scroll through the list of menu options on the top CU’s LCD until **Upload System Configuration** is highlighted.

Important! Only load your CoachComm configuration file to the top CU. Loading the file to the bottom (secondary) CU may cause system malfunction.

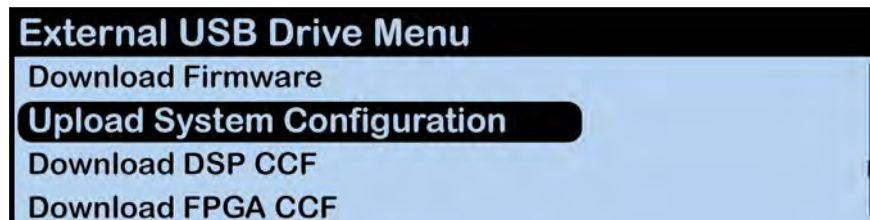

Figure 65: CU LCD Upload Configuration File Prompt

3. Press the top CU’s enter button and scroll until you find the configuration file you wish to use, then press enter to select it.

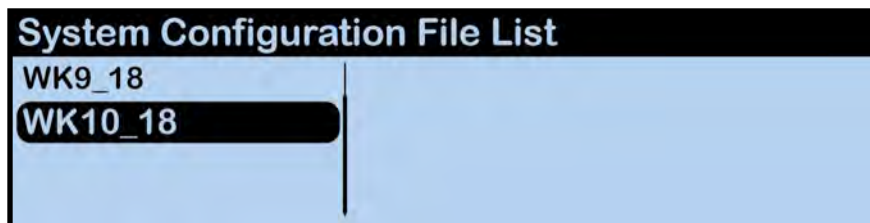

Figure 66: CU LCD List of Available Configuration Files

- The top CU screen will display a progress message while the new configuration file loads.

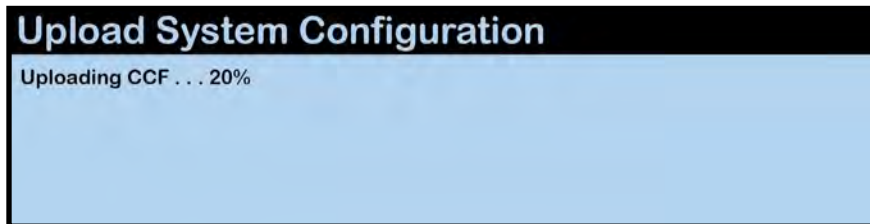

Figure 67: CU LCD: Sample CCF Upload In Progress Screen

- Once the configuration file has finished loading, the top CU will display the following message: "Upload System Configuration. CCF Upload Complete." along with a configuration file summary. A prompt will instruct you to "Please cycle power to Control Unit and any connected devices." Reboot both CUs.

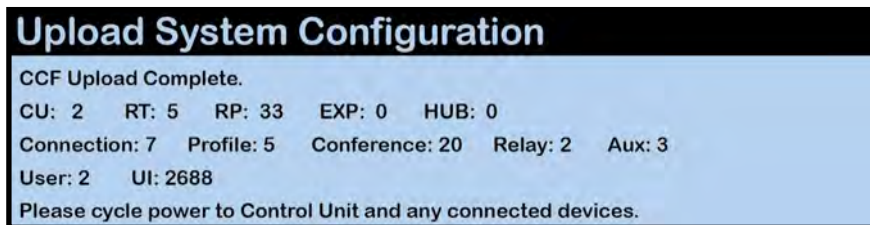

Figure 68: CU LCD: Sample CCF Upload Completed Screen

- Select either **Home** or **Away** when prompted on the top CU. During startup, the configuration file (CCF) will begin loading while the Home/Away prompt is displayed on the top CU. A progress bar shows the load process on the bottom CU. Once the Home/Away prompt is cleared, the CCF load progress can be seen on both CUs.



Figure 69: CU Home/Away Prompt and Progress Bar

- Wait until the CUs display the "CCF Loaded" message along with a configuration file summary. (The bottom CU will take about 30 seconds longer than the top.) When the CCF load is complete, the home screen will display on the front of the CU(s) and you can proceed with operation.

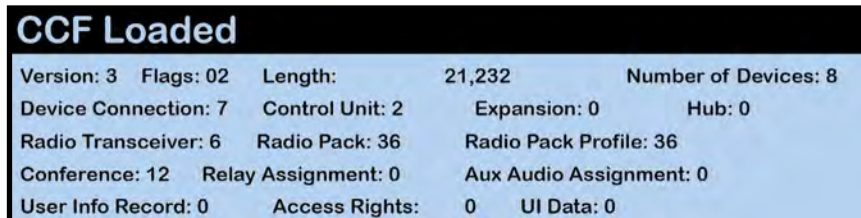

Figure 70: CCF Loaded Confirmation Screen

X-Ware

X-Ware is X-System's proprietary intercom management software, and its easy-to-use touch screen interface provides fast access to critical information and settings, allowing efficient management of large systems.

Within X-Ware, you can manage user settings, set up and manage profiles, assign dry pairs, and access system diagnostics.

Home Screen

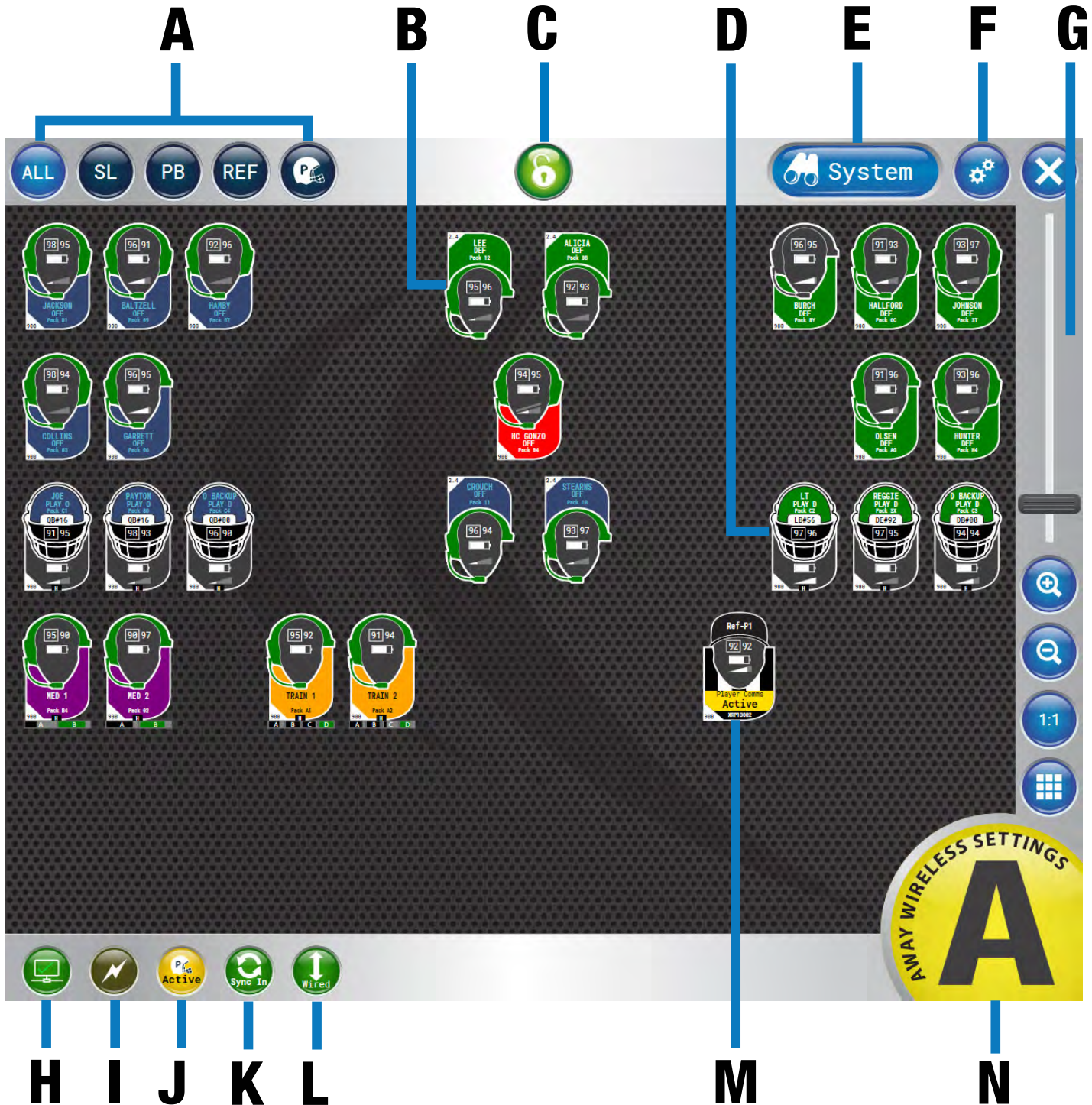

Figure 71: X-Ware Home Screen

When X-Ware opens, the Home screen displays an overview of icons that represent all RPs on the system and their current status on the system. This is the default screen that displays during game time.

- A. **Icon Filter Buttons** - Shows all RP icons, sideline (“SL”) icons, or press box (“PB”) icons.
- B. **Coach RP Icon** - Contains the Profile Name, Active Conference, Pack Name, and indicators for link quality, battery, volume, and frequency. The icons can be positioned to your liking by dragging them to a location on the screen.
- C. **Lock-Out Button** - Locks X-Ware. If a passcode has been set up by a system administrator, unlocking requires passcode entry. This prevents unauthorized access. See page 74 for more.
- D. **X-System Player Icon** - Contains the Profile Name, Active Conference, Pack Name, Player Position & Number, and indicators for link quality, battery, volume, and frequency. The icons can be positioned to your liking by dragging them to a location on the screen.

Note: *Products and software associated with X-System Player and Referee Interrupt are only functional with the X-System Player upgrade package.*

- E. **System Button** - Opens X-Ware’s additional Radio Transceivers, Radio Packs, and Conference views.
- F. **Advanced Settings Button** - X-Ware’s Advanced Settings interface is where the core operational settings for the system configuration reside. Changes to these settings can impact system performance if made improperly. In particular, changes to these settings during “live” operation on game day should be avoided. It is highly recommended you contact CoachComm customer support prior to game day if changes are desired.
- G. **Zoom** - Slider bar and other view options allow you to adjust the magnification of the Home Screen view.
- H. **CU LAN Connection Indicator** - Green illumination of this indicator confirms that the Control Unit and X-Ware are connected and communicating. When not illuminated, an “X” will appear in the indicator meaning the Control Unit is not connected to X-Ware.
- I. **Sideline Cart Power Status Indicator** - Green illumination of this indicator confirms that the Sideline Cart is operating on AC power. When illuminated red, your Sideline Cart is operating from battery power, and the indicator will also display the Cart’s remaining battery percentage.

Note: *X-Ware has no power status indicator for the Wireless Press Box Unit; therefore, this indicator may be absent or may appear grayed out in a local Wireless Press Box configuration. See “Using Dry Pair with Wireless Press Box (with Wired Backup)” on page 95 for more information about this possible scenario.*

- J. **Player Communications Status Indicator** - Yellow illumination of this indicator confirms that player communications are active. When illuminated red, player communications have been muted by the referee.
- K. **Sync Connection Status Indicator** - Green illumination of this indicator confirms that sync is connected.
- L. **Wired Interface Status** - Green illumination of this indicator means that all wired connections are active. Red indication (with black diagonal line) indicates that at least one wired connection has been turned off.
- M. **Referee Interrupt RP Icon** - Contains the Profile Name, Pack Name, Communication Status of X-System Player, and indicators for link quality, battery, volume, and frequency. The icons can be positioned to your liking by dragging them to a location on the screen.

Note: *Products and software associated with X-System Player and Referee Interrupt are only functional with the X-System Player upgrade package.*

- N. **“Away” Indicator** - If your system is set as the “Away” team, a yellow Away indicator will display in the bottom right-hand corner of the Home screen. If your system is set as the “Home” team, no icon will display.

Not Pictured: Audio Recording Status Indicator - See “Audio Recorder” on page 64 for more information.

RP Icons

The RP Icon represents each individual Radio Pack and X-System Player on the Home Screen and RP Profile Screen. The icon appearance can be customized from the Profile Management tab in X-Ware’s advanced settings; see “Customizing RP Icon” on page 70 for more information about that process.

Coach RP Icon

The icon’s headset illuminates green when talk is active. The entire icon will glow red when the RP’s battery is low. The icon color can be customized via the Group Management tab in X-Ware’s advanced settings; see “Customizing Profile Groups” on page 71.

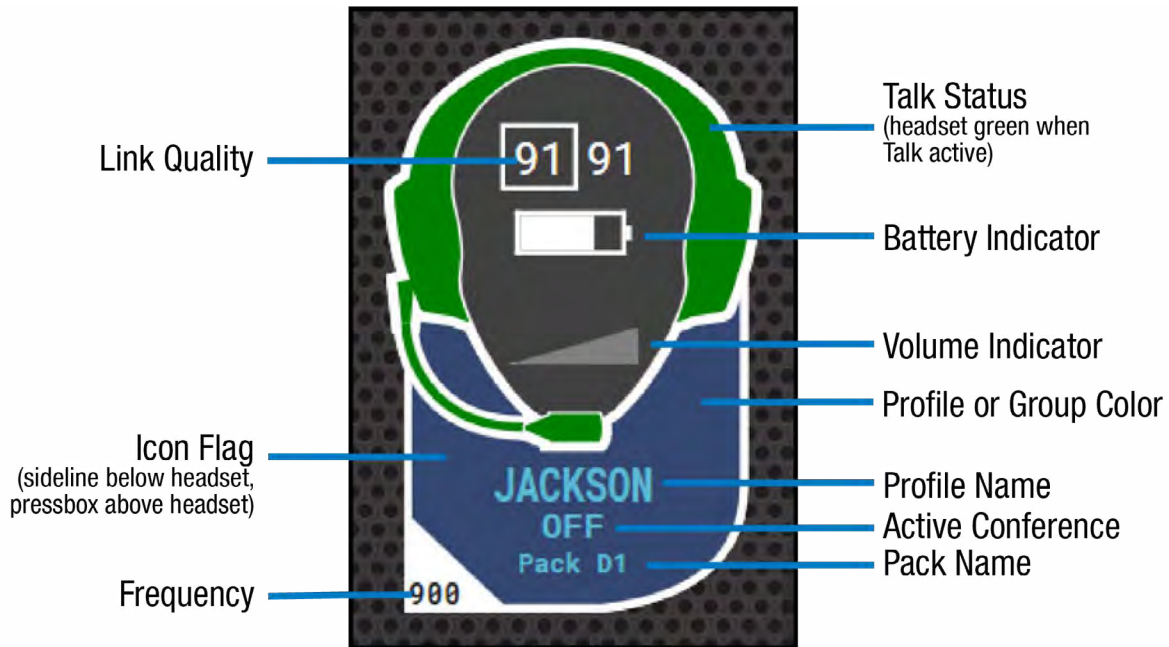

Figure 72: X-Ware Coach RP Icon

Note: When an RP is in High Density Mode, the Link Quality in the box will show blank when no talk button is engaged.

High Density-enabled RPs will show a small “H” at the bottom of the icon flag. The XRP-22 and XRP-44 will show the conferences underneath the icon flag. The Conference box is gray with low volume and Talk off. As the volume is increased on the conference, the box will turn black from left to right. When Talk is on, the box will illuminate green. See Figure 73 for examples of both.



Figure 73: RP Icon of XRP-44 in High Density Mode

X-System Player Icon

The icon's flag illuminates red when communication to the X-System Player is muted by the referee. The entire icon will glow red when the RP's battery is low. The icon color can be customized via the Group Management tab in X-Ware's advanced settings; see "Customizing Profile Groups" on page 71.

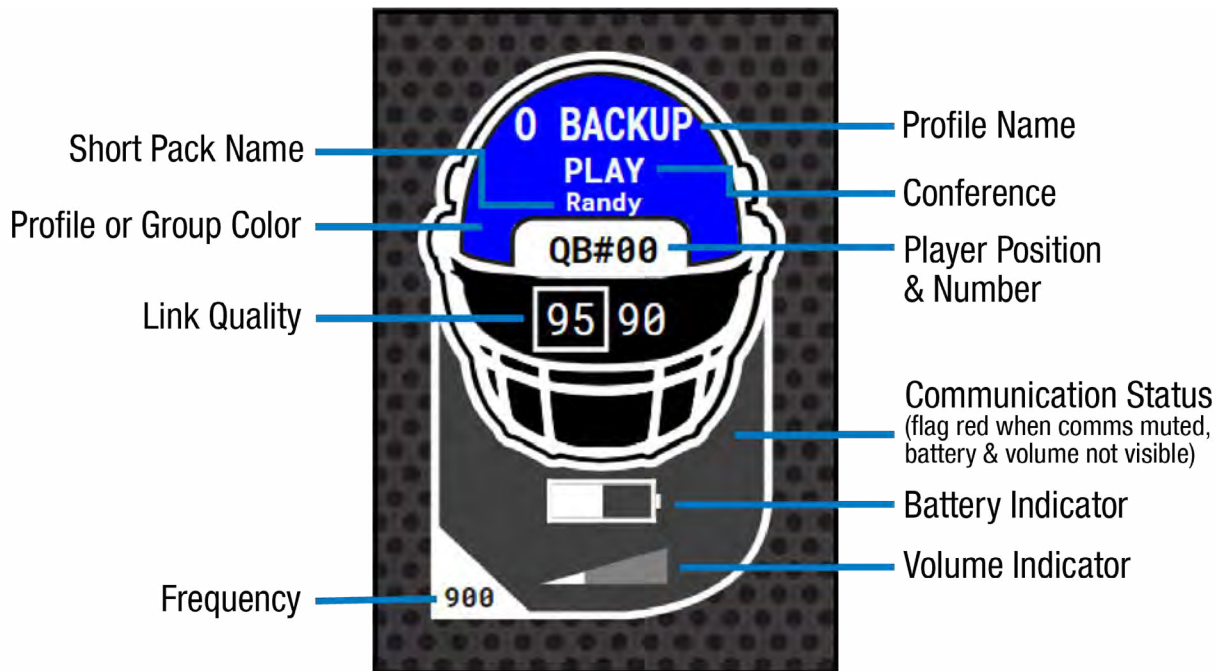

Figure 74: X-Ware X-System Player Icon

Referee RP Icon

The icon's yellow flag illuminates red when communication to the X-System Player is muted by the referee. The entire icon will glow red when the RP's battery is low. The icon color can be customized via the Group Management tab in X-Ware's advanced settings; see "Customizing Profile Groups" on page 71.

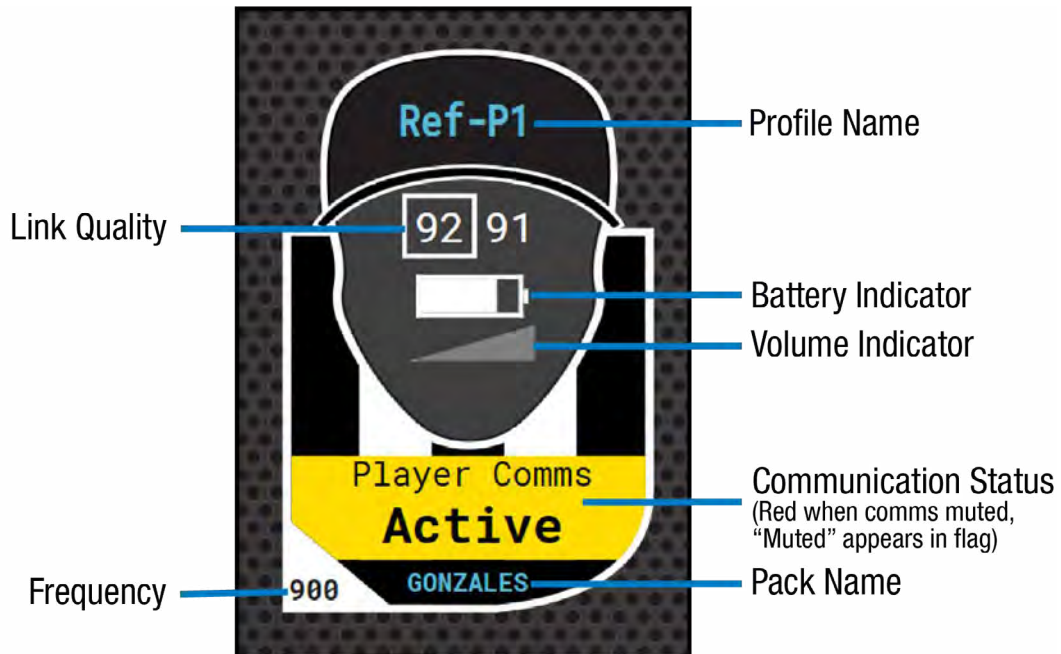

Figure 75: X-Ware Referee RP Icon

Profile Screen

Access the RP Profile screen from the System button or by tapping/clicking on a particular RP icon from the Home screen. This view provides details about the selected RP, including a “live” view of that RP’s real-time display and available conferences. From this screen, you can view the RP status, assign conferences, assign a new profile, view conference members, and show the RP user’s accessibility to other members.

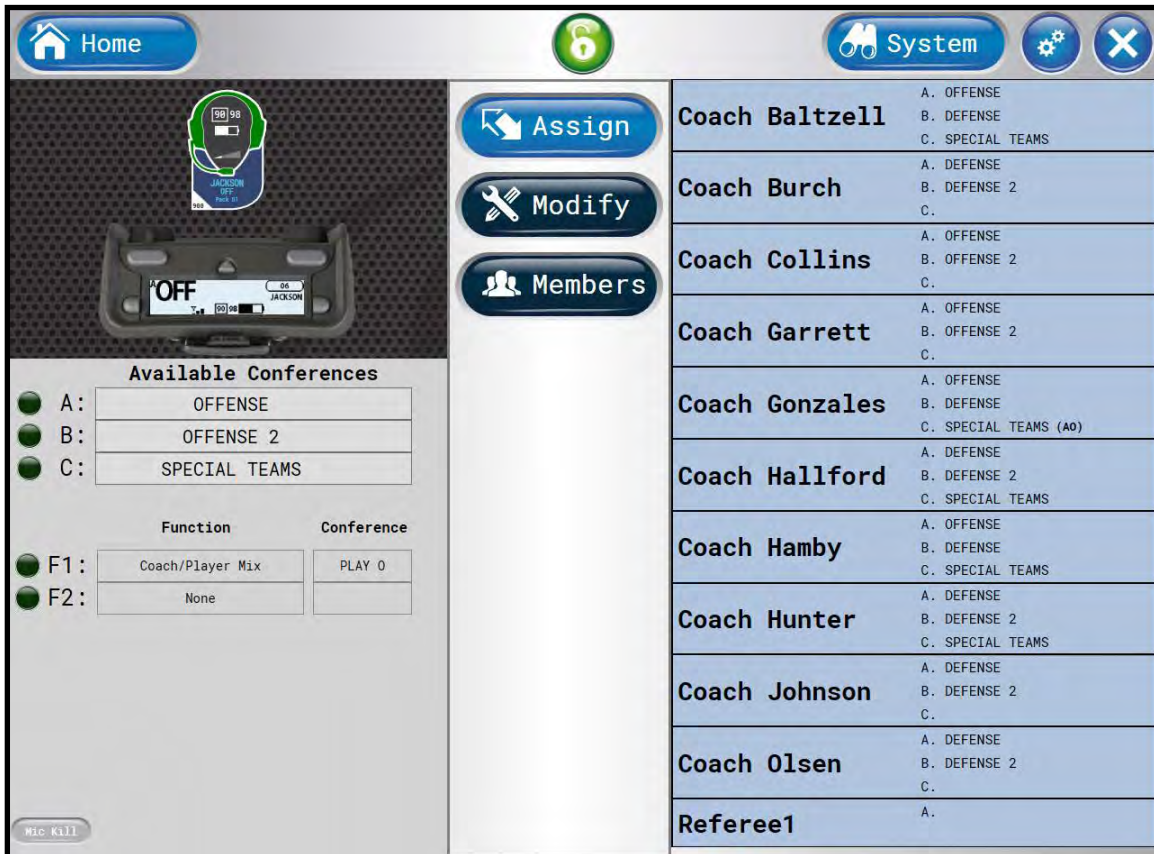

Figure 76: X-Ware RP Profile Screen

Note: Changes to the Function Button assignments shown in the image above can only be made in X-Ware Advanced Settings and not in this screen. The F1/F2 display is for status only.

Assigning New Conferences

The list of available conferences on the RP Profile Screen displays the conferences currently assigned to that RP’s Profile. An illuminated green indicator shows the RP’s current active conference.

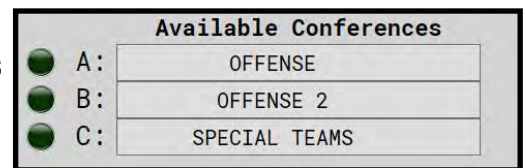

Figure 77: RP Profile Screen’s Available Conferences List

You can quickly edit these assigned conferences by tapping/clicking on any conference and selecting the new assignment from the conference list that displays.

Note: If you change a conference on a profile, all Radio Packs with that profile will change also.

Once a Referee profile is assigned to an RP, the pack must be re-paired before it can be assigned a coach profile. Products and software associated with X-System Player and Referee Interrupt are only available with the X-System Player upgrade package.

Mic Kill

The Mic Kill button on bottom left the RP Profile Screen allows you to remotely turn off the selected RP’s active Talk.

Note: Not available for Always On and Disable Talk button modes.

Assigning New Profiles

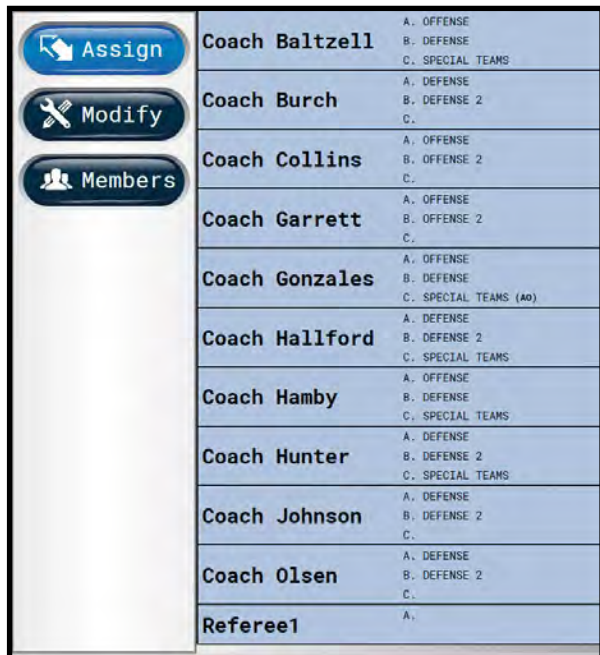

Figure 78: X-Ware Assign Profile View

The Assign button enables you to quickly assign a new profile to the selected RP. The right-hand list displays the available profiles for the type of RP selected (i.e., only 900MHz profiles will display if you selected a 900MHz RP, only XRP-13 profiles will display if you select an XRP-13 RP, etc.). To change the profile, tap/click the desired profile from the list. Confirm your selection on the prompt that displays. You can choose whether to load user settings from the new profile or retain the selected RP's current user settings. (User settings include the items listed under the "Modify" view. See page 60 for more information.)

If needed, you can also change an RP's profile assignment from the Control Unit menu; see page 82 for more information.

Modify Settings



Figure 79: X-Ware Modify Settings View



Figure 80: X-Ware XRP-22 & XRP-44 Modify Settings View

The Modify button displays a list of User Settings that can be customized for the selected RP. You can choose to retain the profile's default settings or customize the settings once the profile is applied. The XRP-22 and XRP-44 Volume sliders are vertical to allow for all volume options (only 2 sets of sliders will show on XRP-22 settings).

The settings available on this screen will be different for X-System Player and Referee Interrupt packs. See "Appendix C: CoachComm X-System Coach to Player Communication" on page 124 for more information on X-System Player.

Note: Products and software associated with X-System Player and Referee Interrupt are only functional with the X-System Player upgrade package.

Members View

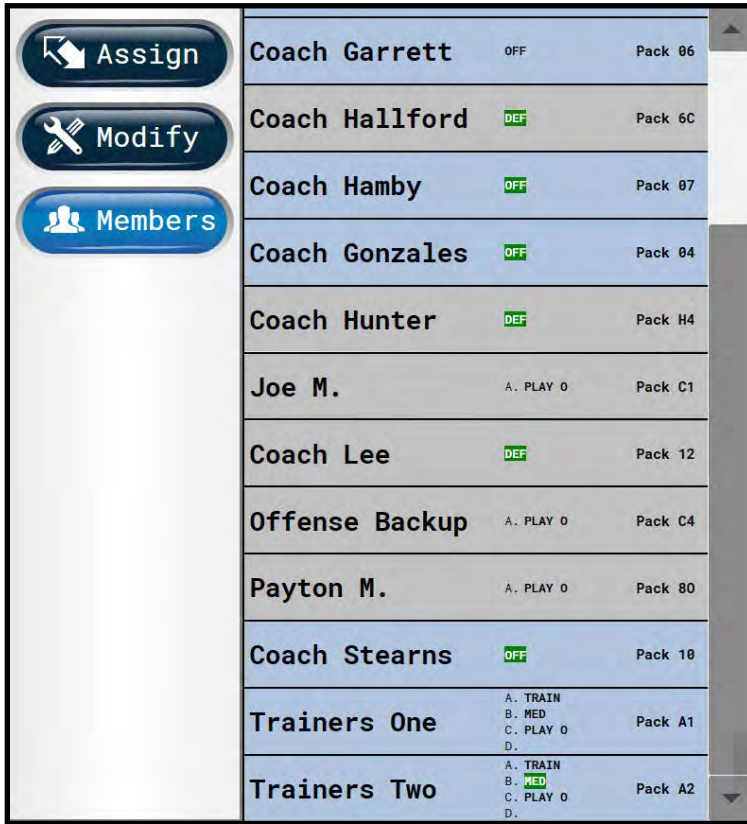

Figure 81: X-Ware Members View

The Members button enables you to view a list of all users the selected RP has access to. Users not on the selected RP's active conference will be grayed out with black text. RPs that are not logged in will be grayed out with gray text.

Clicking one of the users on the list will take you to that user's RP Profile view.

Additional System Views

Radio Transceivers View

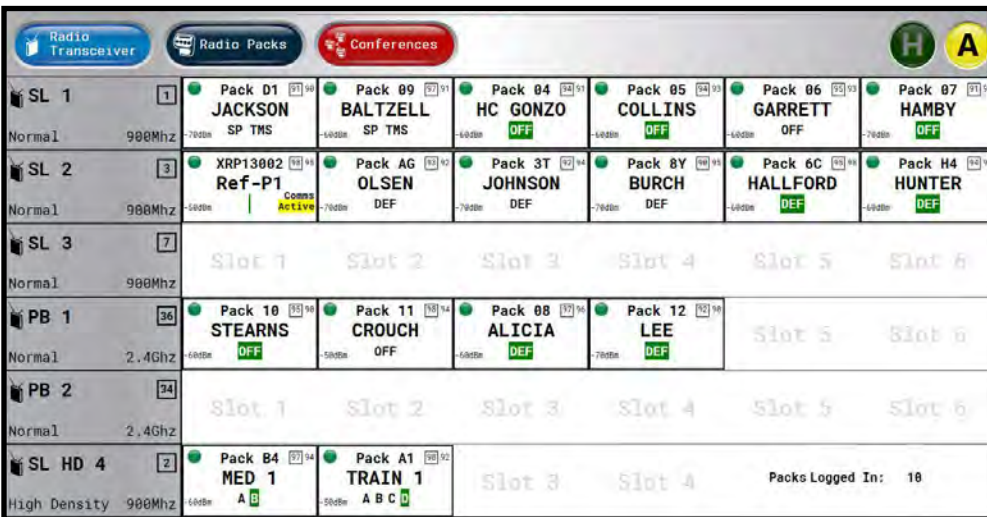

Figure 82: X-Ware Radio Transceivers View

The Radio Transceivers view provides information for each RT currently connected to your X-System.

This view also provides another place to view your system's "Home" or "Away" setting. (For more information about this setting, see page 81.)

Each RT icon displays the RT's name, hopping pattern, mode, and frequency. Each paired RP displays to the right of its RT icon, and their icons display the device status (green for normal, red for error), RP name, link quality, profile name, and active conference. (The conference displays green when the talk button is active.)

Note: High Density RT rows will show details of only the RPs that are currently using one of the four talk slots. Other RPs logged in to that RT will be counted to the right of the talk slots.

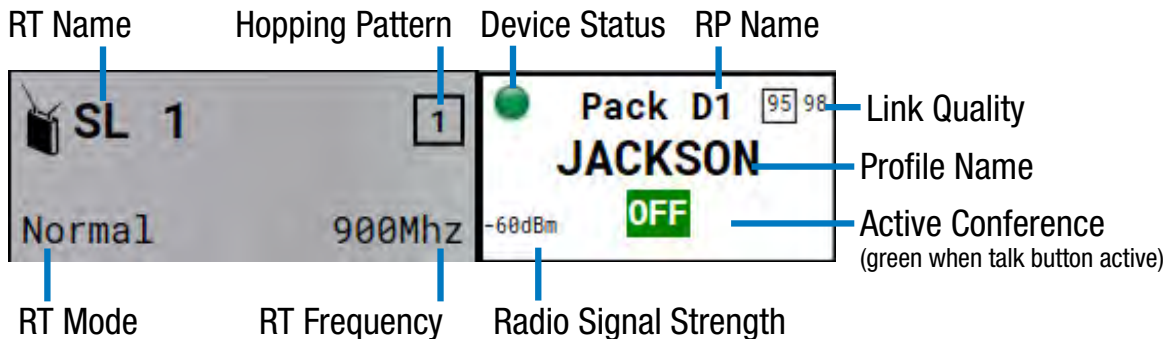

Figure 83: Radio Transceiver View Detail

Radio Packs View

RP Profile	Current RT	Active Conf	LQ	LQ	RSSI	Batt	Conf A	Conf B	Conf C	Conf D	Pack Name
JACKSON	SL 1 Normal 900Mhz	SP TMS	96	91	-60 dBm	09h:31m	OFF	OFF 2	SP TMS		Pack D1
JOE	SL HD 4 High Density 900Mhz	PLAY 0 Player Comms Active	92	94	-70 dBm	09h:31m	PLAY 0				Pack C1
JOHNSON	SL 2 Normal 900Mhz	DEF	95	90	-60 dBm	09h:31m	DEF	DEF 2			Pack 3T
LEE	PB 1 Normal 2.4Ghz	DEF	98	90	-50 dBm	09h:31m	DEF	DEF 2	SP TMS		Pack 12
LT	SL HD 4 High Density 900Mhz	PLAY D Player Comms Active	97	98	-60 dBm	09h:31m	PLAY D				Pack C2
MED 1	SL HD 4 High Density 900Mhz	A B	91	91	-70 dBm	09h:31m	MED	TRAIN			Pack B4
MED 2	SL HD 4 High Density 900Mhz	A B	95	98	-60 dBm	09h:31m	MED	TRAIN			Pack 02
O BACKUP	SL HD 4 High Density 900Mhz	PLAY 0 Player Comms Active	97	96	-60 dBm	09h:31m	PLAY 0				Pack C4
OLSEN	SL 2 Normal 900Mhz	DEF	92	98	-70 dBm	09h:31m	DEF	DEF 2			Pack AG
PAYTON	SL HD 4 High Density 900Mhz	PLAY 0 Player Comms Active	97	97	-60 dBm	09h:31m	PLAY 0				Pack 80
Ref-P1	SL 2 Normal 900Mhz	DEF	92	93	-70 dBm	09h:31m					XRP13002
REGGIE	SL HD 4 High Density 900Mhz	PLAY D Player Comms Active	93	90	-70 dBm	09h:31m	PLAY D				Pack 3X
STEARNS	PB 1 Normal 2.4Ghz	OFF	93	90	-70 dBm	09h:31m	OFF	OFF 2	SP TMS		Pack 10
TRAIN 1	SL HD 4 High Density 900Mhz	A B C D	98	91	-50 dBm	09h:31m	TRAIN	MED	PLAY 0		Pack A1
TRAIN 2	SL HD 4 High Density 900Mhz	A B C D	95	90	-60 dBm	09h:31m	TRAIN	MED	PLAY 0		Pack A2

Figure 84: X-Ware Radio Packs View

The Radio Packs view provides a list of active RPs, along with the following information about each one: Profile Name, Current RT, Current Conference, LQ, RSSI value, Remaining Battery Time, Assigned Conferences, and Radio Pack device name.

This list can be sorted by clicking on any column header. You can also filter the list by clicking on **All**, **Sideline**, or **Press Box**, and add additional filter groups if desired by using the Group Management feature. (See page 71 for more information about Group Management.)

You can also click on any RP in the list to access that RP's Profile View.

Conferences View



Figure 85: X-Ware Conferences View

The Conferences view displays a list of the system’s conferences and dry pair connections.

Clicking a conference from the list will display the active users on that conference in real time.

Move a conference assignment from one dry pair to another by selecting the dry pair (turning it yellow) and then selecting the new conference assignment. Confirm your change in the pop up that displays. You can also assign conferences to dry pair connections from the CU; see page 81 for details on that process.

Note: Red colored icons (Conferences, the ports, and the Wired Interface Status icon) indicate that at least one port is muted.

Audio Recorder

The Audio Recorder function allows for up to two conferences to be recorded on the system's PC. These audio files (.mp3) can then be used for further off-line evaluation or for troubleshooting when necessary.

To record audio, choose the source (Src) for the audio output (the audio meter will indicate the presence of audio once a source is chosen regardless of recording status). Choose one or two conferences to record in the A and/or B selection. Click REC to record the selected conferences. A tray icon with REC will appear when audio is recording (See Figure 87). To stop the recording, click the REC button that now shows a white square.



Figure 86: Audio Recorder



Figure 87: Audio Recording in Progress

Note: Audio Recorder function requires installation of 6-Foot 3.5mm TRS to Dual 1/4 in. TS Stereo Audio Breakout Cable (CAB-6MTRS-C2R) into X-System.

The MP3 file will be saved to the computer desktop in a folder labeled "CoachComm-Recordings". The file name will be labeled as follows: "CCFNAME_YYYYMMDD_AorB_ConferenceLongName_HHMMSS.mp3".

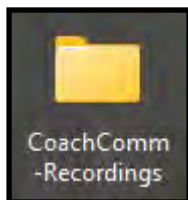

Figure 88: Audio Recording Folder on Desktop

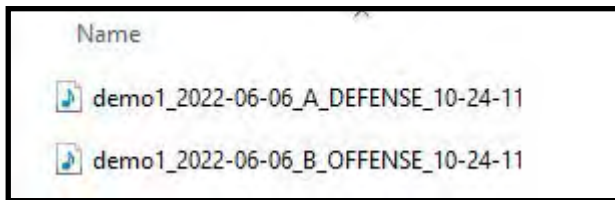

Figure 89: Example Audio Files

2-Wire Mute/Activate

The 2-Wire tab in the Conferences View allows users to mute or activate all ports. The tab indicates the number of ports muted, activated, and unassigned in the 2-Wire tab (See Figure 90 below). X-Ware indicates if any ports are muted with the Wired Interface Status tray icon and when the Conferences View button is red (See Figure 85 for red Conferences View button). (See “Home Screen” on page 55 for tray icon status when all ports active.)



Figure 90: 2-Wire Mute/Activate



Figure 91: Wired Interface Status (at least one port muted)

To Mute or Active all ports, click the relevant button on the 2-Wire tab. A pop-up message will appear informing the user of the affect on communications the selection will have. Choose “Yes” to proceed with the Mute or Activate function.

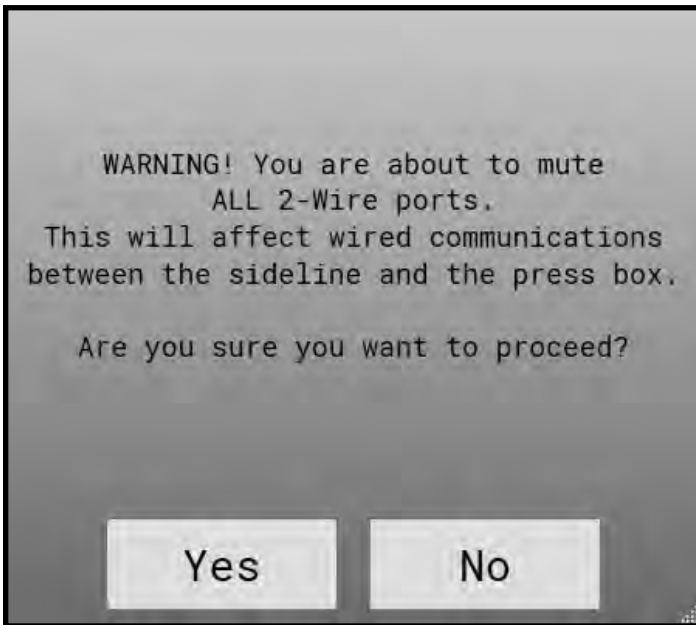

Figure 92: All Mute Message

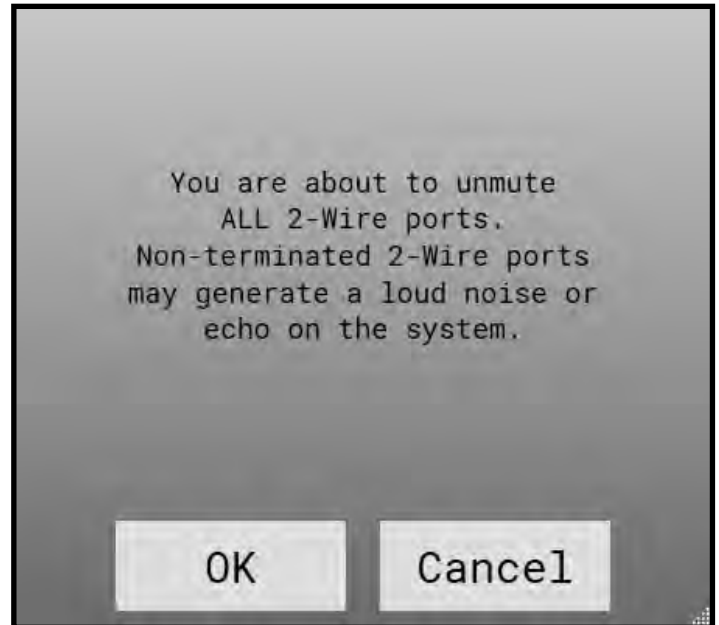

Figure 93: All Active Message

Note: Use X-Ware Advanced Settings to mute a single or specific ports.

See Figure 94 and Figure 95 for examples of muted and active ports in the Conferences View. Unassigned ports will be grayed out.

Auto Null Process

Nulling is required to electronically balance an audio device, in this case a Control Unit, with a 2-wire intercom system.

Important! This procedure **MUST NOT** be performed while the system is in use in a game environment. This process uses audible tones that will disrupt communication between users.

1. Ensure that all sideline and press box units are connected via stadium wiring and that wired BeltPacks are connected to the press box system prior to nulling.
2. Using X-Ware, null each Control Unit, one at a time, at initial system setup.

Note: You may also null a system from the Control Unit menu without X-Ware. The **Run Auto Null** command is found under the Wired Settings menu.

The Auto Null function is available from the Conferences View in X-Ware. To null a Control Unit, follow the steps below:

1. Select the Auto Null button on the Control Unit you wish to null.

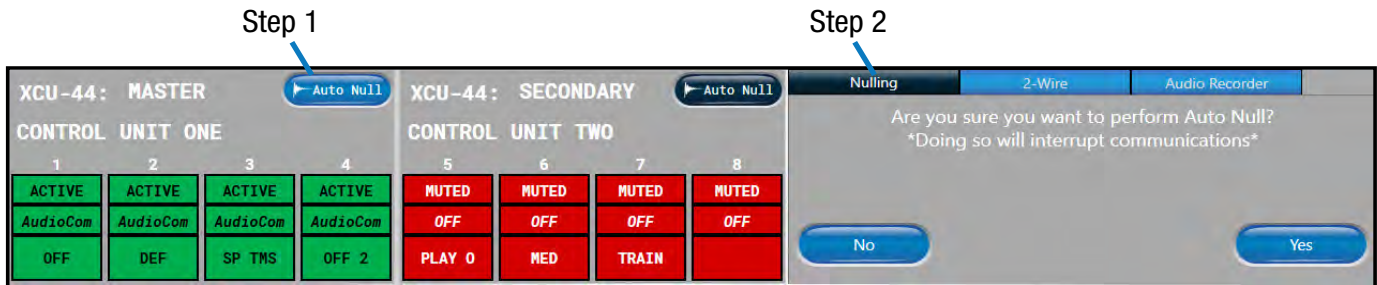

Figure 94: X-Ware Auto-Null Command

2. Confirm your decision to auto null on the prompt that displays.
3. Once nulling begins, a nulling status screen will display, indicating that null is in process on the Control Unit's port indicated in red.

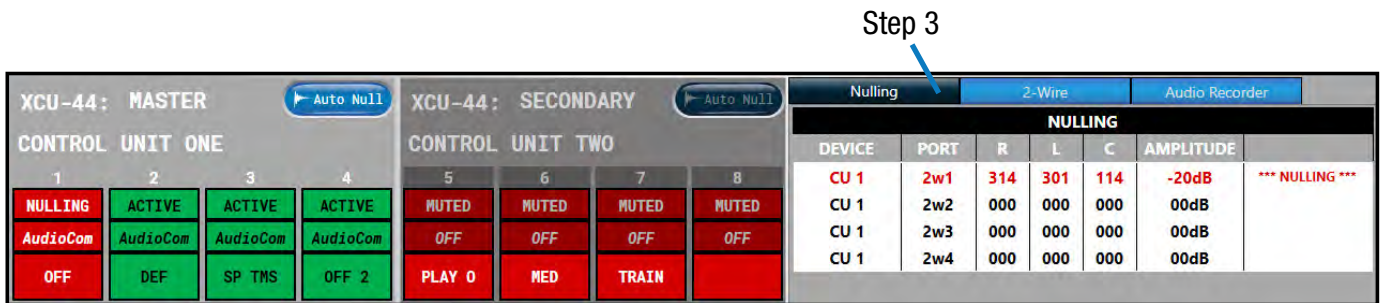

Figure 95: X-Ware Auto-Null In Progress

X-Ware Advanced Settings

X-Ware’s Advanced Settings interface is where the core operational settings for the system configuration reside. Changes to these settings can impact system performance if made improperly. In particular, changes to these settings during “live” operation on game day should be avoided.

Opening a System Configuration File Offline

You can edit a previously saved System Configuration File in X-Ware to make offline edits. You can install X-Ware on a PC other than the cart PC; see “Installing and Updating X-Ware” on page 86 for that process.

To open a saved configuration file:

1. Hold down the CTRL key on your keyboard and click on the X-Ware desktop icon. (Hold down the CTRL key until the program opens, then release it.) This bypasses the Control Unit connection function, and allows X-Ware to open in an offline state directly to the Advanced Settings view.
2. Click the **Open File** shortcut button in the top left corner of the screen. A windows directory browser will open.

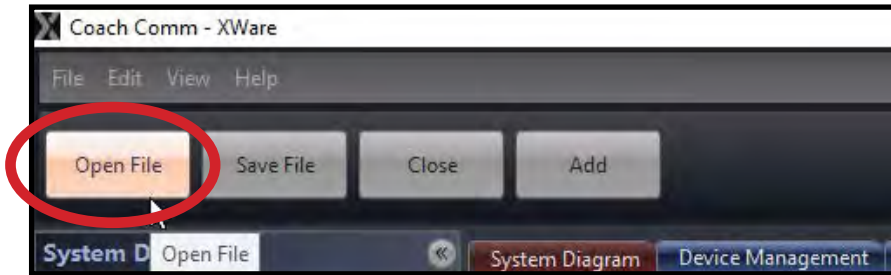

Figure 96: Open Saved .pcf File

3. Navigate to the location of your saved .pcf file, and open it.
4. Use X-Ware’s advanced settings functions to make edits to the file. When your edits are done, save the .pcf and load it to the top CU using the procedures detailed on page 52.

Ping Devices

RP Ping Device (button in Device Detail View and in Device Management List View) Device location function where, when activated, will cause the backlight of the selected RP’s LCD display to blink until deactivated by the operator.

RT Ping Device (button in Device Detail View and in Device Management List View) Device location function where, when activated, both the top ping light and the mode LED on the bottom of the RT will blink until deactivated by the operator.

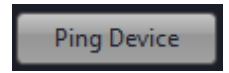

Figure 97: Ping Device Button

View Paired Radio Packs per CU

Radio Pack pairings can be viewed in X-Ware under Device Management > Control Units. The pairings are to the right of each CU in the system.

The image shows a screenshot of the X-Ware interface. The top navigation bar includes 'System Diagram', 'Device Management', 'Conference Management', 'Profile Management', 'Group Management', 'Event Log', and 'Firmware'. The left sidebar has 'Control Units', 'Radio Transceivers', 'Radio Packs', and 'Hubs'. The main area displays a table with columns for 'Long Name', 'Short Name', 'Model', and 'Synchronicity'. Below this, there are two tables. The first table lists 'Radio Pack Pairings' with columns for 'Long Name', 'Short Name', 'Model', 'RF Mode', and 'Serial Number'. The second table lists 'Radio Pack Pairings' with columns for 'Long Name', 'Short Name', 'Model', 'RF Mode', and 'Serial Number'.

Long Name	Short Name	Model	Synchronicity
CONTROL UNIT	CU 1	XCD300000000	Master

Long Name	Short Name	Model	RF Mode	Serial Number
Radio Pack 20	Pack20	XRP 11-900	Normal	XRBA00000000
XRP 11-900-001	XRP11001	XRP 11-900	Normal	XRBA00000007
XRP 44-900-001	XRP44001	XRP 44-900	HiDensity	XRBA00000002
XRP 22-900-001	XRP22001	XRP 22-900	HiDensity	XRBA00000007

Figure 98: Radio Pack Pairings List

Unpair Radio Packs

Radio Packs can be unpaired from the CU Menu in the Paired RP List or in X-Ware by right-clicking the Radio Pack in the RP and choosing Unpair.

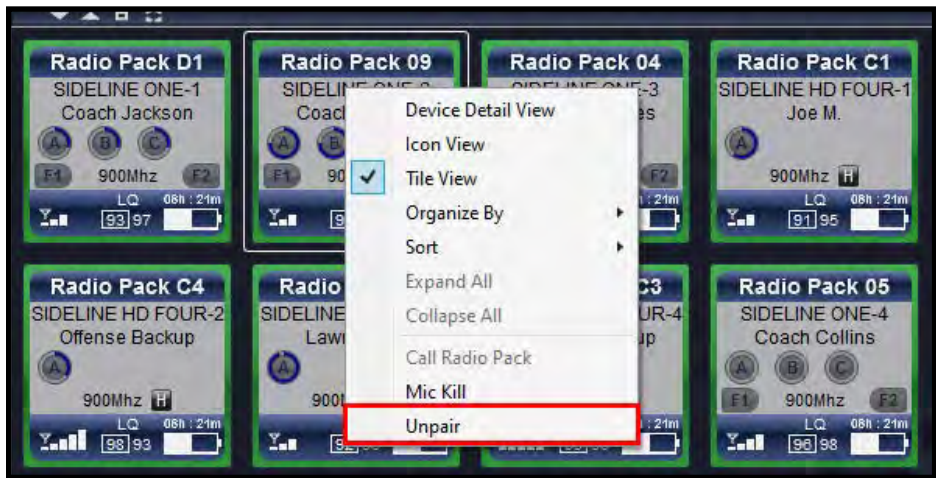

Figure 99: Unpair RPs Option in Advanced Settings

Note: RPs with a Referee profile cannot be unpaired from X-Ware and must be unpaired via CU.

Adding a Conference

Use the procedures below to add a conference to your X-System configuration. For information on assigning conferences, see “Assigning New Conferences” on page 59 and “Assigning Conferences to Dry Pair Connections (Wired Port)” on page 82.

1. Open X-Ware and access the Advanced Settings window.

Note: You can add a conference to a “live” system or to an “offline” system. If you make the change while offline, you’ll have to first open a saved .ccf file to edit.

2. Click the **Conference Management** Tab. This tab displays a list of the conferences in the open system configuration file.

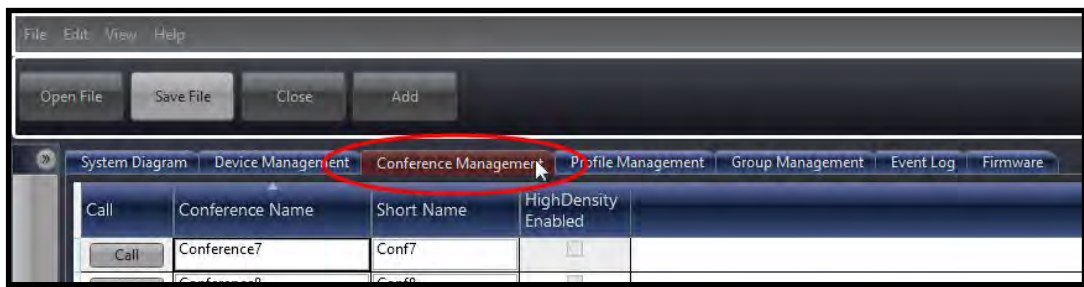

Figure 100: X-Ware Conference Management Tab

3. Click the **Add Conference** button in the bottom left corner of the screen. A new conference will appear in the list.

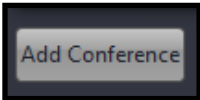

Figure 101: Add Conference Button

4. Click in the Conference Name column for the new conference and type a new long name for the conference. (Limit of 16 characters).
5. Click in the Short Name column and type a new short name for the conference. (Limit of 8 characters).
6. If you’re editing your .ccf offline, save the .ccf and load it to the top CU using the procedures detailed on page 52.

Adding a Profile

Use the procedures below to add a profile to your X-System configuration. For information on assigning profiles, see “Assigning New Profiles” on page 60 and “Assign Profiles from the Control Unit” on page 82.

1. Open X-Ware and access the Advanced Settings window.

Note: You can add a profile to a “live” system or to an “offline” system. If you make the change while offline, you’ll have to first open a saved .ccf file to edit.

2. Click the **Profile Management** Tab. This tab displays a list of the profiles in the open system configuration file.

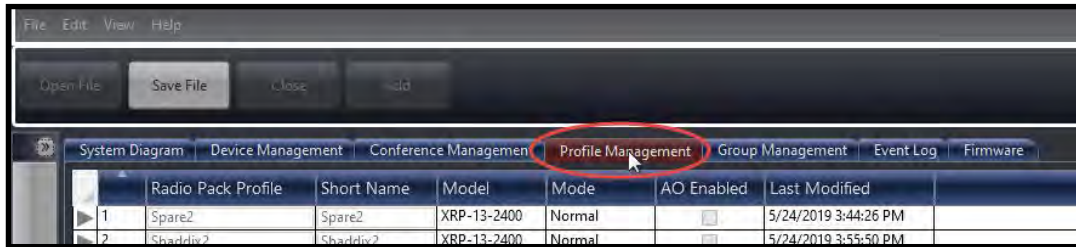

Figure 102: X-Ware Profile Management Tab

3. Click the **Add Profile** button in the bottom left corner of the screen. A new profile will appear in the list.

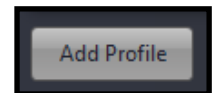

Figure 103: Add Profile Button

4. Double-click on the newly created profile. The profile’s detail screen will display.



Figure 104: X-Ware Profile Detail Screen

5. Customize the profile settings to fit your needs using the various drop-down and text entry fields on this screen.
Note: Some of the profile settings are not currently used for X-System devices, (e.g., Call Alert and the RP Function Buttons). Leave these fields at their factory default. Other settings are used with X-System, but they **SHOULD NOT** be changed from the factory settings (e.g., Scan List). CoachComm recommends contacting Customer Support if you have questions about profile settings or configuration details.
6. When your settings are done, click the **Upload Changes** button at the top of the profile detail screen.
7. If you're editing your .ccf offline, save the .ccf and load it to the top CU using the procedures detailed on page 52.

Editing or Cloning Profiles

To edit an existing profile, double-click the profile name from the list on X-Ware's Profile Management tab, then complete the desired edit and click the **Upload Changes** button at the top of the profile details screen. In addition, if you're editing your .ccf offline, save the .ccf and load it to the top CU using the procedures detailed on page 52.

To create a copy of the profile, click the **Clone Profile** button at the top of the profile detail screen.

Customizing RP Icon

Customize an RP Icon's appearance by changing the **Icon Flag**, **Headset**, **Profile Color**, and **Font Color** fields on the relevant Profile's detail view. Changes will be reflected on every RP Icon for Radio Packs using that profile. In addition, if you're editing your .ccf offline, save the .ccf and load it to the top CU using the procedures detailed on page 52.

- **Icon Flag:** Choose from **Sideline** or **Pressbox**, and the icon's curved rectangle area will move above or below the icon's face accordingly.
- **Headset:** Choose from **Single**, **Double**, or **Listen-Only**, and the icon's headset will match the selection. (Listen-only removes the headset's boom, and the headset will never illuminate green for active Talk.)
- **Profile Color and Font Color:** Override the colors determined by the Profile's Group assignment by choosing a color from this field. You can also click on the green circle or the **Restore Colors** button to restore the Profile icon to the Group's colors. See "Customizing Profile Groups" on page 71 for more information about Group assignments.

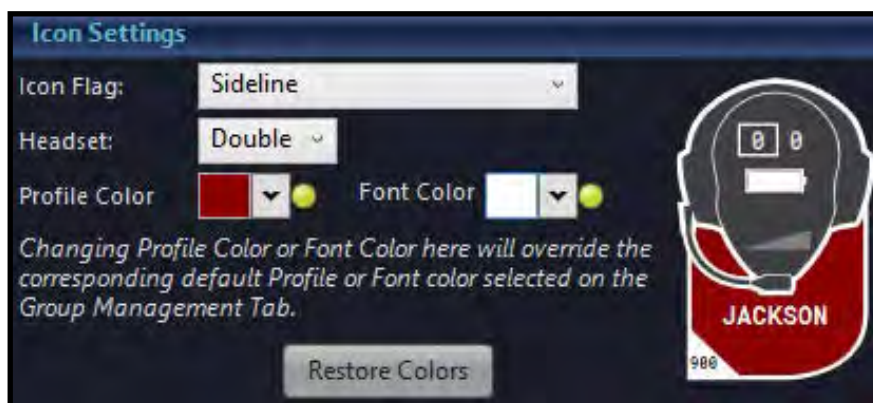

Figure 105: Icon Settings Section of Profile Detail View

Customizing Profile Groups

Use the procedures below to use the Profile Group feature of X-Ware.

1. Open X-Ware and access the Advanced Settings window.

Note: You can add a Group to a “live” system or to an “offline” system. If you make the change while offline, you’ll have to first open a saved .ccf file to edit.

2. Click the **Group Management** Tab. This tab displays a list of the X-Ware groups available to any profiles in the open system configuration file.

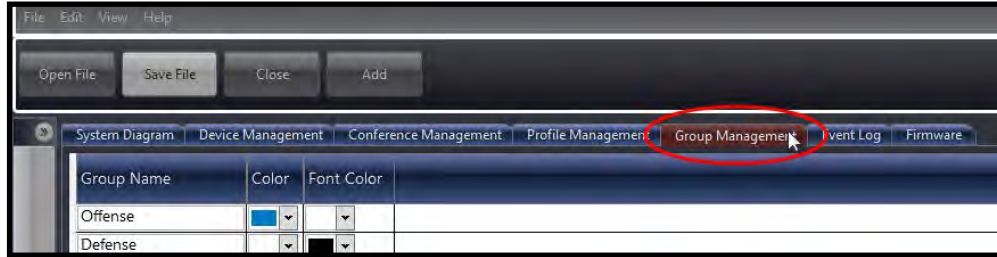

Figure 106: X-Ware Group Management Tab

3. Click the **Add Group** button in the bottom left corner of the screen. A new profile group will appear in the list.

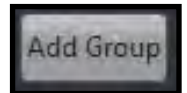

Figure 107: Add Group Button

4. Double-click on the newly created group. The group’s detail screen will display.



Figure 108: X-Ware Group Detail Screen

- Click in the Group Name field and type a new name for the group.
- Open the drop-down color pickers in the Color and Text Color fields, and choose a color to represent the group (see Figure 109). This color choice appears on the RP Icons (X-Ware’s Home screen) for profiles with the group assignment.

Note: Clicking on the color picker’s **Advanced** tab opens an alternate window where more advanced color options are available. If desired, you may enter hexadecimal color values for an exact color match to your school colors.

- To associate profiles with any group, select them from the All Profiles list on the left-hand column, then use the arrow button to place the selected profiles into the right-hand “In this group” column. You may also open the profile’s detail view and edit the Profile Group field (in the Global Profile Settings section).

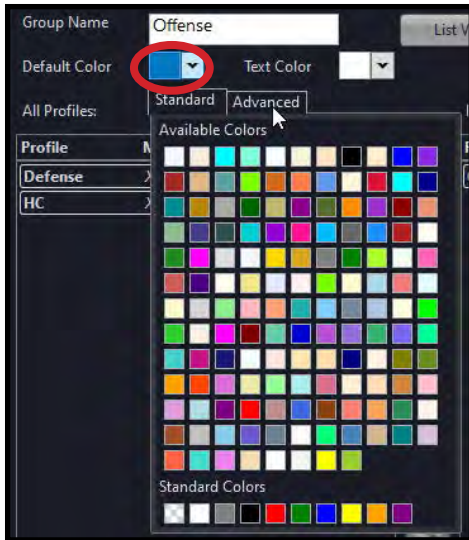

Figure 109: Editing Group Colors

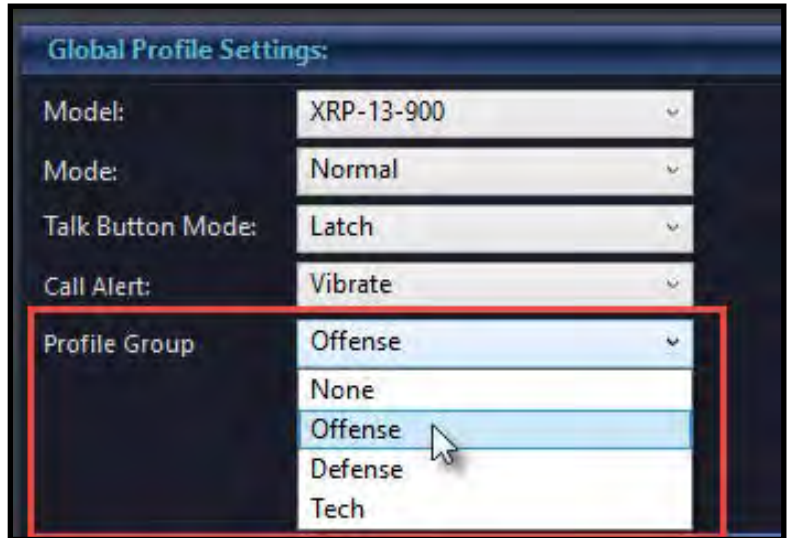

Figure 110: Profile Group Selection - Profile Detail View

- If you’re editing your .ccf offline, save the .ccf and load it to the top CU using the procedures detailed on page 52.

Setting Up Audio Overlay

When Audio Overlay is enabled on a Profile's Conference C, the audio from that Conference will be heard in addition to the audio of the pack's active conference (A or B).

Enable this feature beside **Audio Overlay (AO)** on the relevant Profile's detail view (Conference C only). Confirm your change on the prompt that displays. In addition, if you're editing your .ccf offline, save the .ccf and load it to the top CU using the procedures detailed on page 52.



Figure 111: Audio Overlay Toggle on Profile Detail View

When Audio Overlay is enabled on a profile, the **AO Volume** field becomes available on the Game Day Interface (Profile Screen > Modify Settings view). This setting determines the overlaid audio's volume as a percentage of the overall RP volume. AO volume is also indicated on the RP Icon above the volume ramp.



Figure 112: AO Volume Setting on Profile Screen



Figure 113: AO Volume Indicator on RP Icon

Enabling Access Rights

When X-Ware’s Access Rights are enabled, a passcode has been set by the system administrator. If X-Ware is locked while access rights are enabled (using the small padlock icon in the center of the Home screen), X-Ware is “view-only” and the passcode is required to unlock the screen.

Use the following procedures to set a system passcode:

1. Open X-Ware and access the Advanced Settings window.
2. Click **Edit** from the X-Ware Menu.
3. Choose **User Access Rights**, then click **Set Passcode**. A dialog box will display.
4. Enter a unique four-digit passcode for your system in the **Passcode** field, then click **OK**.

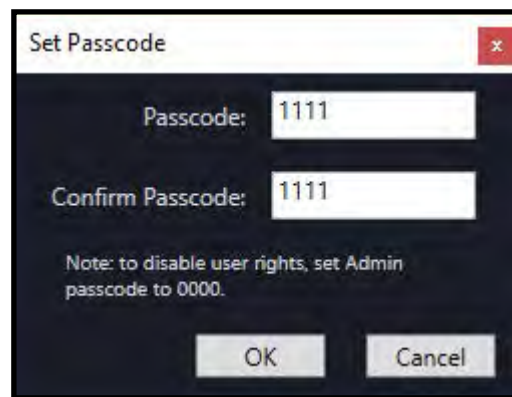

Figure 114: Set Passcode Dialog Box

Note: X-Ware will not require a passcode to unlock if you set the passcode to “0000.”

5. If you’re editing your .ccf offline, save the .ccf and load it to the top CU using the procedures detailed on page 52.

Note: Your system may already have a default passcode set up from its original factory configuration. If you experience a locked Home screen at startup following a firmware update, use “1111” as the unlock code. After that, you can set up a new passcode in X-Ware Advanced Settings. Call CoachComm Customer Support for assistance if required.

Sync In Indicators

Sync In Status can be viewed on the CU primary operating screen and in X-Ware. See the images below for Sync In Indicators on the CU menu screen, System Diagram View, CU Management Tab, and top right with the Mini View Toggle and X-Ware Access Rights Lock. The Sync Indicator can also be seen on the X-Ware front end at the bottom (See “Home Screen” on page 55).



Figure 115: Sync In Indicator on CU Primary Operating Screen



Figure 116: Sync In Indicator on System Diagram CU

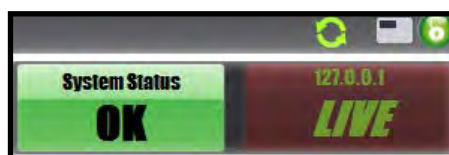

Figure 118: Sync In Indicator on Top Right



Figure 117: Sync In Indicator on CU Management Tab

Operational Modes

High Density Mode is a selectable mode of operation for existing hardware that will allow user densities to increase by more than fivefold.

When selected, this new mode of operation will allow for up to 32 Radio Packs (RPs) or X-System Player Modules to log into a single Radio Transceiver (RT). In addition, users will have the flexibility to mix “Normal” Mode-engaged RPs and RTs along with separate High Density Mode-engaged RPs and RTs on the same system to allow for application specific setup with ultimate adaptability.

***Important!** Normal Mode is the default setting for devices in X-Ware. In order for proper use of Operational Modes, applicable devices and conferences need to be set using the same mode. Specifically, RP profiles and RT RF modes need to be set appropriately, and for High Density mode, up to four conferences need to be assigned as High Density conferences.*

High Density RT Deployment

See “Coach to Player High Density RT Deployment” on page 140.

Contact CoachComm Customer Support at 1.800.749.2761 for deployment recommendation.

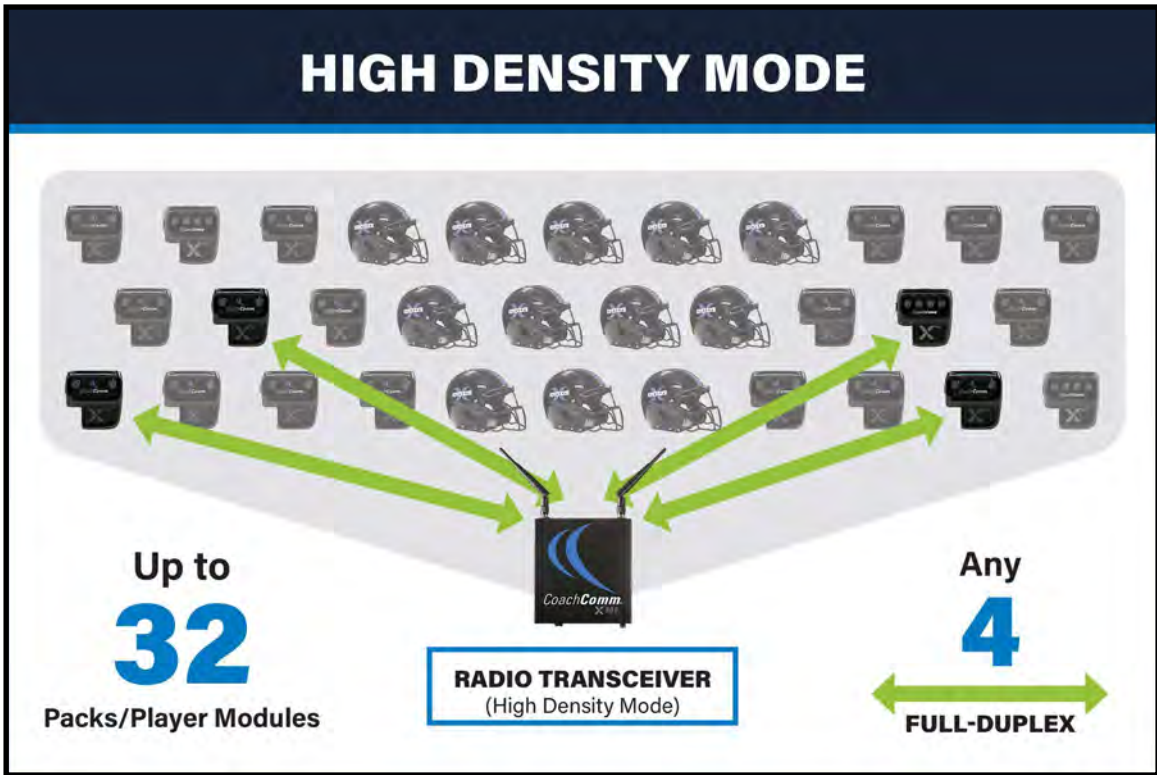
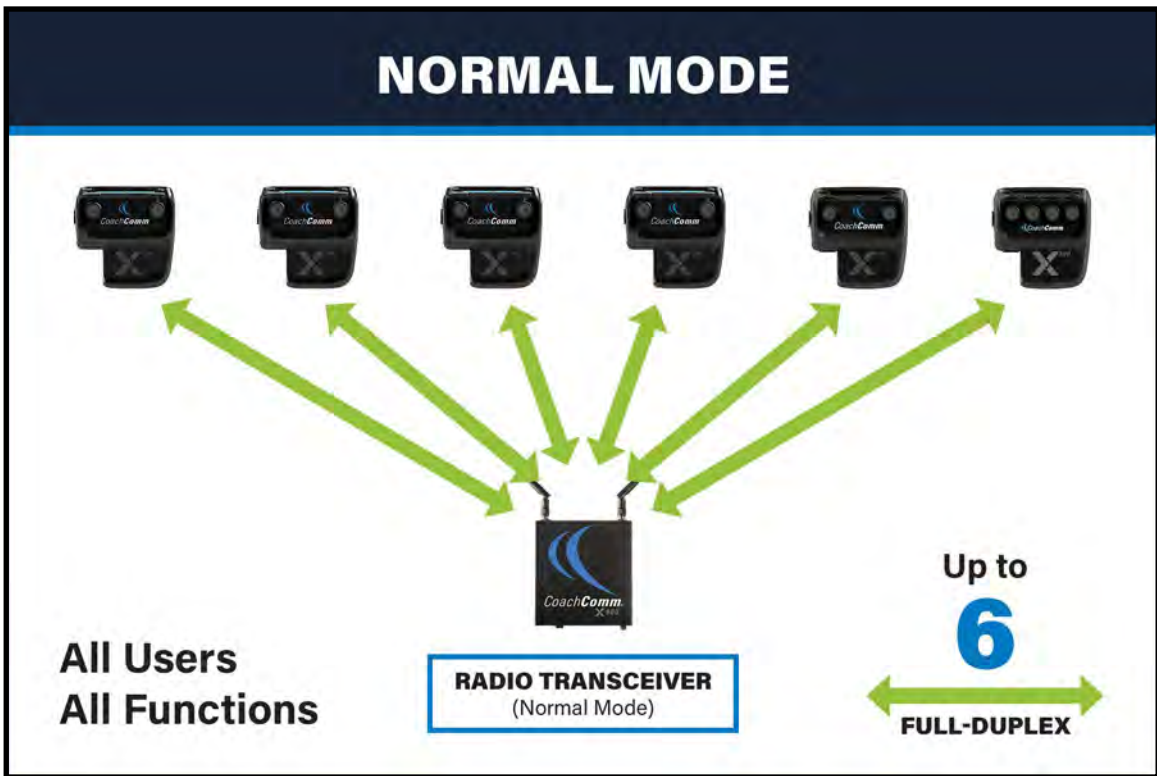

Changing Operational Mode

To choose High Density Mode for RTs in X-Ware, double-click on a Radio Transceiver in the Device Management list view to access its device view and view/edit its settings.

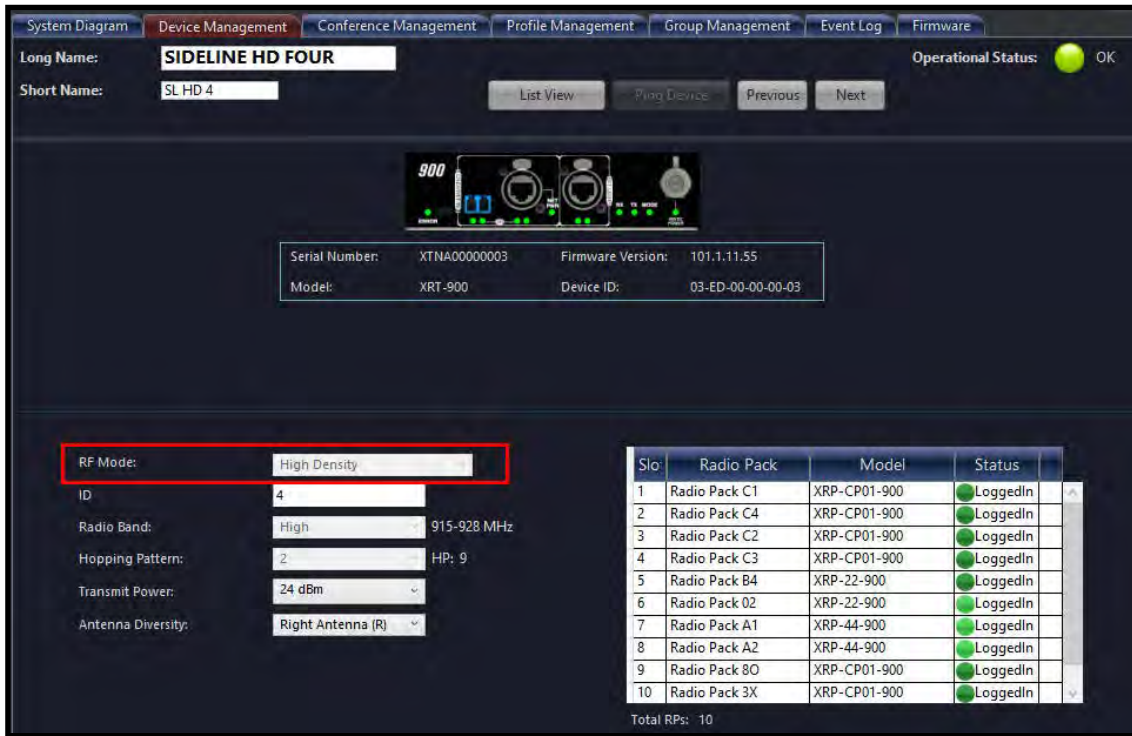

Figure 119: RT Operational Mode

To choose High Density Mode for RP Profiles in X-Ware, double-click on a Profile in the Profile Management list view to access its detail view and view/edit its settings. For more information on RP Profiles, see “Adding a Profile” on page 69.

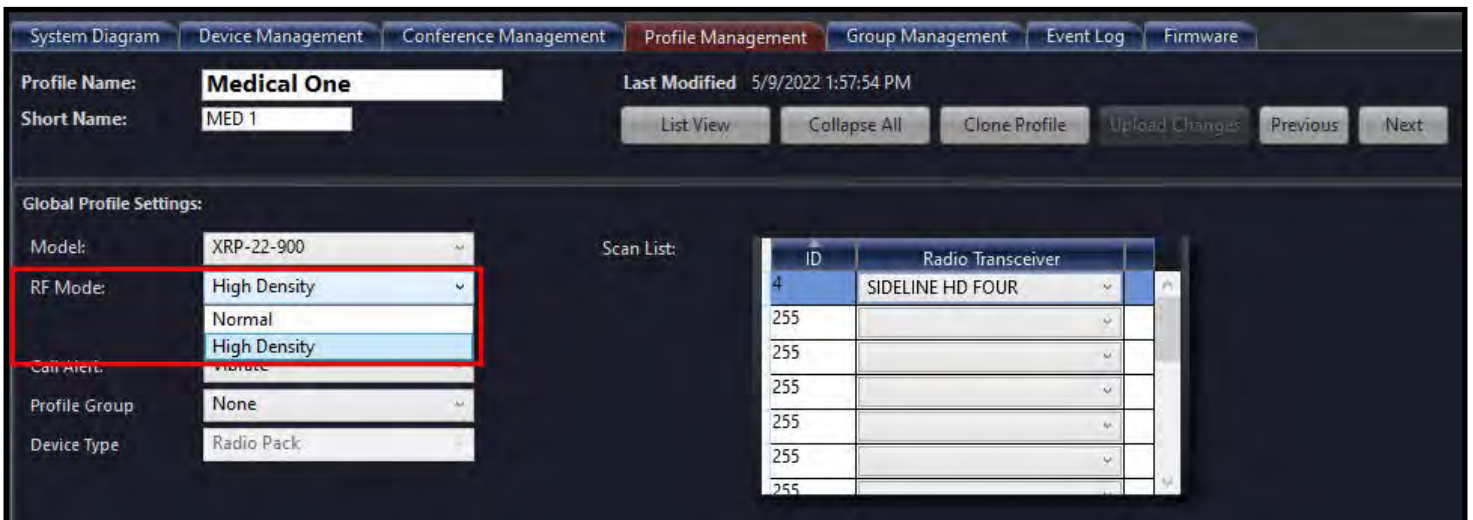

Figure 120: RP Profile Operational Mode

System Setup and Operation

RT Mast Assembly

The RT mast and bracket system elevates your RTs above obstructions to allow for clear line-of-sight with wireless Radio Packs on the sideline. The Mast extends 18 feet above the ground, and mounted at its top (parallel to the sideline) are up to two aluminum RT brackets (which support up to 4 RTs per bracket). This bracket system enables all RTs to be mounted at the same height and allows faster setup and takedown since the devices and interconnect cables can remain attached to RTs from week-to-week.

The RTs are connected to the rest of X-System via the provided heavy-duty Cat 5e Ethernet cable. When mounting your mast and connecting your main RT cable, take care to route the cables so that they are not pinched or bent aggressively.

***Important!** Use only approved antennas with your RTs to avoid possible FCC violations!*

Cover Your RTs

When using your RTs in a wet environment, protect them with a protective enclosure that will not interfere with the RF (for example, a clear plastic bag). CoachComm recommends either covering each RT individually with small bags or covering the whole RT bracket with a large bag. The X-System Radio Transceivers are weather-resistant, including gaskets intended to prevent moisture entry from the top and sides. The Cat 5e cable connection on the bottom is not water tight.

Mast Safety



-  **CAUTION:** Please follow these safety considerations each time you deploy your RT mast.
- Be sure that the cart is stable and parked before raising the mast.
 - Deploy cart stabilizers for leveling.
 - While one person is capable of deploying and raising the mast assembly, it is recommended that this process include at least two people.
 - ALWAYS pay attention to your surroundings when raising or lowering the mast and NEVER pull the pin on the cart's receiving tube until you have a firm handle on the mast itself.
 - Verify all locking pins are fully inserted into their proper locations.



Figure 121: One Sideline Cart RT Mounting Bracket on the RT Mast

Mast Assembly Steps

The following steps are also outlined (and illustrated) in the Game Day Setup section on page 14 of this manual.

-  **CAUTION:** The following steps should be performed by at least two people.
- 1. Remove the mast from its storage area and insert it into the locked and upright mast receiving tube.
- 2. Align the mast so your RT mounting bracket(s) (when attached) will be **parallel to the sideline** and secure the mast with pin 1 at the bottom of the tube.
- 3. Secure the mast and tube with one hand, then remove pins 2 and 3 from the top of the tube. Carefully lower the mast to a bench or chair level with the cart.

-  **CAUTION:** Ensure there is a minimum of 20 feet of clearance beside the Cart before lowering the mast.
- 4. Extend the mast to the desired height, locking each section in place as you go. (A minimum of 12 feet is recommended.)
 - A. If you are not fully extending the mast, align the index holes of the non-extended sections and secure by inserting pin 4. This prevents the mast from rotating while extended.

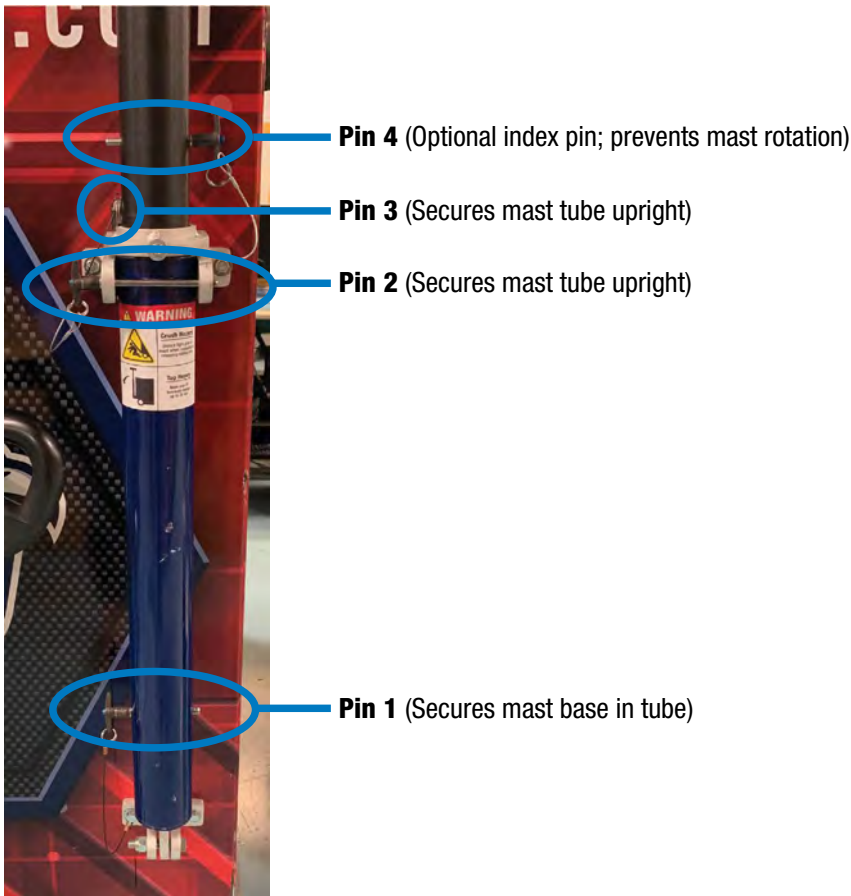

Figure 122: RT Mast Pin Locations

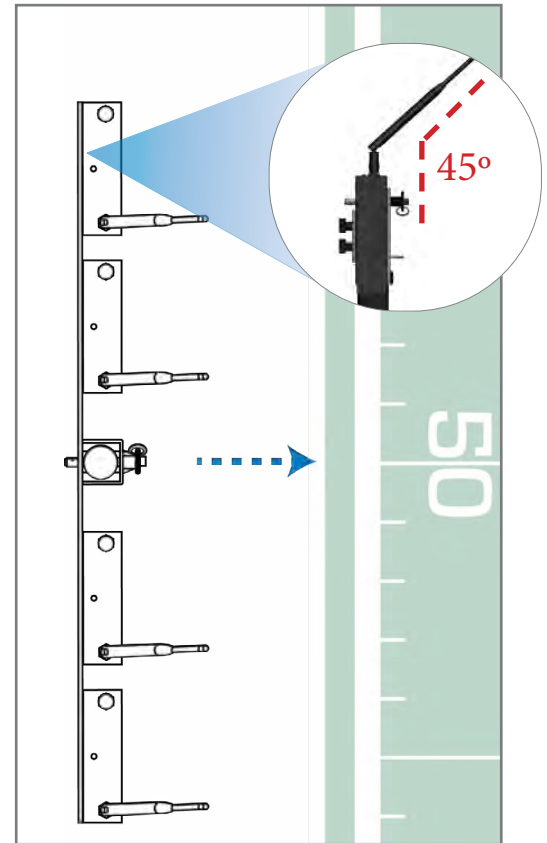

Figure 123: Top View of RT Bracket and Antenna Direction

5. Mount the RT mounting bracket(s) to the top of the mast using the provided pins.
6. Connect the RT cable to the first RT on the top bracket. (See Figure 124.)

Note: If using a second RT bracket, also connect the RT cable to the first RT on the bottom bracket.



CAUTION: Failure to connect the RT cable in the correct port can lead to system configuration errors.

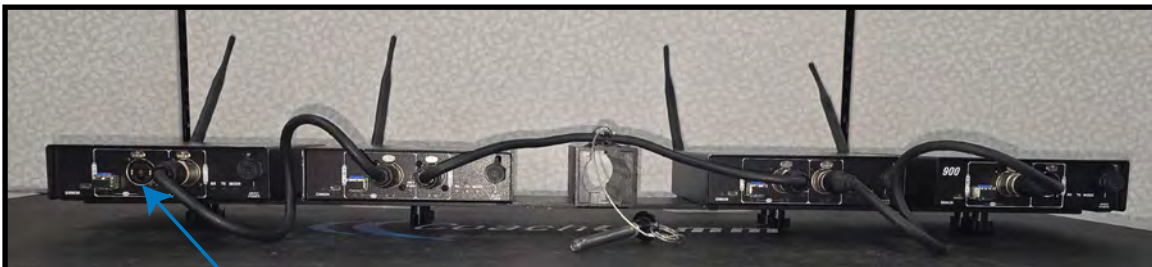

The RT cable from the cart's rear patch panel connects to the X-NET IN port of the first RT.

IMPORTANT: DO NOT connect this cable to an RT LOOP port.

Figure 124: RT Cable Connection Location

7. Attach the cable's strain relief to the eye bolt on the mounting bracket.
8. Bend the antennas so they are parallel to the ground (45° angle between the antenna and the RT) and point their tips toward the opposing team's RT mast.
9. Carefully walk the mast up until the receiving tube is upright and flush with the Cart and secure with pins 2 and 3 (which you removed in step 3).

Connecting One RT Cable

For customers with only one RT rack, mount the rack to the highest point on the mast and connect only one of the RT cables in the bundle from the Cart's rear patch panel. (You may use either red or blue, as long as the same color is plugged into the TOP RT SET port in the Cart's rear patch panel. You should NOT use both red and blue ends with a single RT rack setup.)

Setting Home/Away Status

When you power up the X-System Sideline Cart, a prompt for selecting “Home” or “Away” displays on the top Control Unit LCD. Based on this setting, all of the RTs on the system will be assigned specific hopping patterns by the Control Unit (CU). It is very important to set this status correctly. Hopping pattern coordination prevents interference between X-Systems. During startup, the configuration file (CCF) will begin loading while the Home/Away prompt is displayed on the top CU. A progress bar shows the load process on the bottom CU. Once the Home/Away prompt is cleared, the CCF load progress can be seen on both CUs. When the CCF load is complete, the home screen will display on the front of the CU(s) and you can proceed.



Figure 125: Control Unit Home/Away Status Prompt

Turning On 2-Wire Ports and Adjusting Levels

Some teams elect to turn off their 2-Wire ports for each Control Unit so they can use the Sideline Cart alone for wireless communication during practice. **Always make sure that the 2-Wire ports are turned on prior to game day. Failure to do so will result in no communication between wireless RPs and the wired system.**

To turn ports ON:

1. Navigate through the CU menu to **Wired Settings > Intercom Settings**.
2. Select a 2-Wire port, then press the Enter button. A menu of available types will display.
3. Scroll to select **AudioCom**, then press Enter.
4. Verify that the IN level for the port is **-6**.
5. Verify that the OUT level for the port is **+4**.
6. Repeat steps 1–5 for each 2-Wire port of all connected Control Units.

NOTE: 4-Wire ports are not used in standard X-System operation and should be turned off.

To turn ports OFF: Select **OFF** as the port type.

Wired Settings > Intercom Settings							
DEVICE	PORT	TYPE		MK	ECAN	IN	OUT
XCU441	2w1:	A-C	OFF	OFF	ON	-6	+4
	2w2:	A-C	RTS Ch1	OFF	ON	-6	+4
	2w3:	A-C	AudioCom	OFF	ON	-6	+4
	2w4:	A-C	ClearCom	OFF	ON	-6	+4

Figure 126: Control Unit Intercom Settings Menu

Assigning Conferences to Dry Pair Connections (Wired Port)

You may assign a conference to each dry pair connection for your wired system in the press box. These dry pair connections correspond to the ports on the rear of the CU, and to the thumbwheel settings on the WIMs, so wireless users may access those conferences and communicate with users on wired beltpacks.

There are two ways to assign a conference to a dry pair: assign the conference via X-Ware. (See page 59 for details on that process.) OR assign the conference via the Control Unit's LCD menu, as detailed below.

1. Press the menu button on the front of the top CU.
2. Use the CU's navigation buttons to find and select **System Configuration > Conferences > Assign to Hardware**.
3. Select a Control Unit port from the list and choose a conference assignment for that port from the list that appears.



Figure 127: Control Unit Menu - Conference Assignment

4. Return to the CU Home screen and confirm the change via the Conferences view in X-Ware.

Assign Profiles from the Control Unit

If needed, you may change a device's profile assignment from the Control Unit menu rather than from X-Ware. (For more information about how to do this via X-Ware, see page 60):

1. Press the Packs button on the front of the top CU.
2. Use the CU's navigation buttons to navigate through the menu screens to **Radio Pack Settings > Sort By _____** (where you choose the identifier to sort by).
3. Select an RP or player module from the list and navigate through the sub-menu that displays to **Device Settings > Radio Pack Profile**.
4. Select a profile from the list to assign to the selected device. The device will momentarily log out and lose communication while the profile change takes effect.

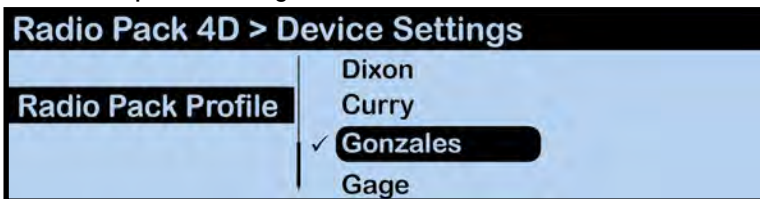

Figure 128: Control Unit Menu - Device Profile Assignment

Wireless Component Setup and Integration

The wireless portion of X-System is an add-on to the wired system. If the wired system is not set up properly or if there is a problem with the dry pair or any aspect of the wired system, the wireless portion may not work correctly.

- **Walk Test the Radio Pack** — Walk testing is very important. If a user tests the units only standing right beside the system unit, he may not discover potential frequency problems. Spread your Radio Packs out along the bench area so they are not piled on top of one another. Walk test each unit from one end of the coach's box to the other, at a minimum. Effective system administrators walk the units on the entire grass surface. Listen carefully on both the Control Unit and Radio Pack for "drop out." Should you have an unacceptable amount of drop out or if the signal sounds poor, you may wish to change antenna location. If a sub-system still does not function properly, set it aside for work later. Remember not to turn off power to the unit, but turn off the TALK button for the unit.
 - » If all wireless to wired (or wired to wireless) users sound too loud or too quiet to the other, use the Control Unit's Intercom Levels menu option to adjust the volume.

- **Turn Off the TALK Button On All Control Units and Radio Packs** — Now that setup of this particular wireless unit is complete, turn off the TALK button on the Radio Pack. This will keep background noise to a minimum. Do NOT turn off the power to the Radio Pack, only the TALK button. Repeat the above steps for all wireless units.

NOTE: Also make sure that all talk lights on all wired BeltPacks are off during testing.

- **Re-Test All Units** — After you have completed the sub-system adjustments, you should go back and walk test the units again. If you find that previously working units are now working incorrectly, you should re-evaluate the changes made above.

If any unit is deemed not usable, turn off the power to that Radio Pack and store the Radio Pack away.

Understanding Link Quality

The Link Quality (LQ) is a numeric value that provides a real-time metric on the quality of communication between the radio in the Radio Transceiver and the radio in the Radio Pack. The LQ serves as a diagnostic tool for proper system operation and troubleshooting Radio Packs.

- With X-System, the receiving LQ signal is reported for both the Radio Transceiver and Radio Pack. The Radio Pack's on-screen LQ indicator with the box around it is the Transceiver's LQ from the RP. If this LQ is lower than normal, then it is an indication that you may have an issue related to interference, the transceiver, or a cable connection. If only the RP's LQ is low, it could be an indication that you may have an issue related to interference or the Radio Pack.
- What should the LQ value be during operation? — There is no exact value that LQ will remain at during system operation. Depending on what degree of outside interference or attenuation (blocking) is present, the LQ will fluctuate during normal operation. Fluctuations in LQ can and will span a wide range of values. The lower the LQ, the poorer the audio quality will be during operation. During start-up, within adequate range and no outside influences present, the LQ should display "99" which is the highest LQ value a Radio Pack or Radio Transceiver can have.
- What if the LQ on a single Radio Pack is below "99" at start-up? — This depends on where the Radio Pack is located at start-up, but if the other Radio Packs on the same Radio Transceiver are at "99" this is a good indication that isolated radio issue exists within that Radio Pack. If the LQ value has dropped considerably lower or if that unit is experiencing poor audio quality, it may require service.

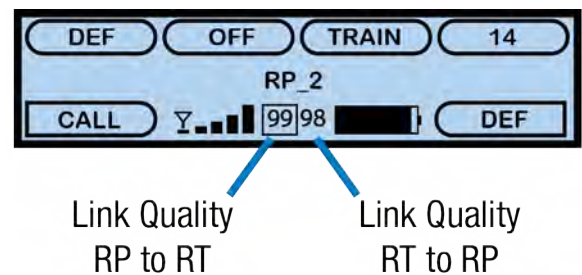

Figure 129: RP Primary Screen LQ Indicator

System Maintenance

Basic Maintenance

CoachComm recommends the following best practices when maintaining your X-System components.

1. At the conclusion of every game, pull the X-System log file from the cart computer for your records or in the event you need to send the file to CoachComm for support.
2. If the system is exposed to rain, dry all parts of X-System carefully, including cables and connectors.
3. Always make sure that nuts and bolts are secure prior to and after moving or operating.
4. Connect or disconnect cables by holding the connectors (not the sheath of the cable) and pressing the release button if applicable.
5. It is recommended that X-System be stored in a climate-controlled environment when not in use.
6. **Storage Temperature:** If a climate-controlled storage space is not available, X-System equipment can be stored in temperatures ranging from 5° to 130° F. However, when going from cold to warm environments, electronics can form condensation, which can cause damage to the electronic components. If storing your system in these types of conditions, wait for the equipment to acclimate to the ambient temperature before using.
7. Store the Sideline Cart with the tow handle in the upright position.
8. Verify that system power is off and that the battery is disabled before storing the system. See additional battery storage safety information below.

Off-Season Storage: Inverter Battery Information

Follow the instructions below for off-season storage and maintenance of your sideline cart inverter's absorbent glass mat (AGM) batteries.



CAUTION: The cart's AC power distribution unit's switch (located on the front rack, behind the acrylic door) must be in the RESET (ON) position for the cart battery bank to charge. CoachComm recommends leaving this switch in the ON position at all times.

You may store your system in the off season in one of two ways: 1) with AC power connected (therefore maintaining battery bank charge using Float Charge Mode) or 2) with the battery bank breaker turned off.

1. Store your system in a climate-controlled area to optimize battery life.
2. If you aren't storing your system with AC power connected, you should turn the battery breaker on and charge your system for about 8 hours every 1–2 months. When finished charging, remember to turn the battery breaker back off for storage.
3. Fully charge your inverter batteries for a minimum of 8 hours before off-season storage.
4. Always charge your system in a well-ventilated area.
5. Check that all wires are connected correctly and tightened properly.
6. Check that no corrosion is present on the battery poles.
7. Check that the compartment is dry and free from acid or water spills. AGM batteries are sealed and spill-proof. Evidence of water or acid in and around the batteries indicates a problem with the batteries.
8. Check that batteries are placed correctly and held down by the battery strap.

Lithium-Polymer Battery Maintenance

Storage of your Lithium-Polymer Batteries

When stored, a battery gradually loses its overall charge time due to internal self-discharge, which may reduce its overall power. If storing Radio Pack batteries for two or more weeks, CoachComm highly recommends storing them at a 40–50% charge level, which generally minimizes any permanent power capacity loss. If storing CoachComm X-System Player Modules for more than a week, disconnect battery from rest of player module assembly.

Unused lithium-polymer batteries may enter into a deep discharge state due to internal self-discharge. Once a battery has gone into deep discharge, its onboard circuit protections inhibit the charger from initiating the charge cycle. If a battery does not accept a charge and the LED displays red in the charger, the battery may be in deep discharge. An attempt to revive the battery can be made by repeatedly inserting and removing it several times from the 5-bay charger (CBT-5BAY-01).

Ambient temperature affects the rate at which lithium-polymer batteries degrade. Batteries also degrade and lose overall power capacity if stored (or used) at higher temperatures.

Proper Disposal of Old Lithium-Polymer Batteries

Batteries that appear swollen, deformed, or damaged, or that do not fit properly should never be used. Properly dispose of any batteries in this condition in accordance with the instructions provided by your local authorities. For more information and local drop-off sites, visit <http://www.call2recycle.org/>.

Battery Shipping Regulations

Rechargeable lithium-polymer batteries are subject to special U.S. and International regulations, particularly regarding transportation. The guidelines detailed in CoachComm's [Lithium-Polymer Battery Shipping Guidelines](#) document comply with updated International Air Transport Association (IATA), International Civil Aviation Organization (ICAO), and U.S. Department of Transportation (DOT) Dangerous and Hazardous Goods regulations.

When shipping equipment to CoachComm that includes batteries, it is the shipper's responsibility to ensure that batteries are properly packaged, labeled, and shipped according to local and international guidelines. "Shipper" is defined as the person or school placing the equipment in the package and offering it to the carrier.

Installing and Updating X-Ware

Use the following steps to update the version of X-Ware on your sideline cart PC or to install an instance on a separate PC.

System Requirements

- Windows 7 or higher
- 4 GB system memory
- Intel Core2 Duo CPU @ 2.67 GHz or better
- 128-megabyte (MB) graphics card
- .NET version 4.8 or higher

Additional Recommendation

- XGA video screen; 1024 × 768 or greater resolution

Update Procedures

IMPORTANT: Be sure to save a copy of your current configuration file before updating X-Ware.

1. Locate X-Ware application files on PC at C:\Program Files (x86)\CoachComm\XWare #.#\.
2. Double-click the “Uninstaller” application file to open the uninstall wizard.

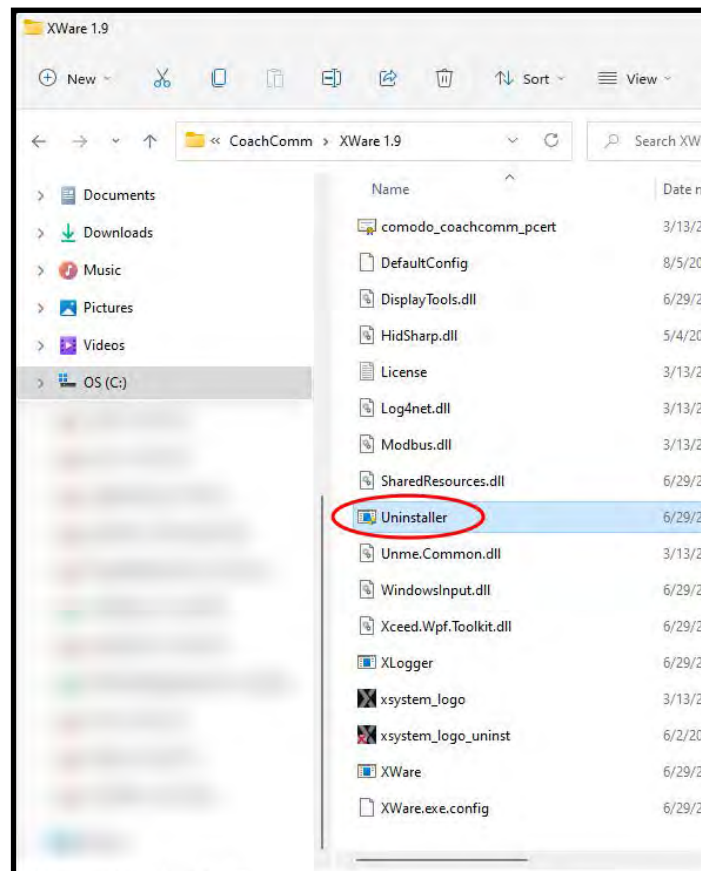

Figure 130: X-Ware Uninstall Application File

Note: You may need to make an exception for the uninstaller program in your PC’s anti-virus or security program for it to run.

3. Click **Uninstall** to begin process.

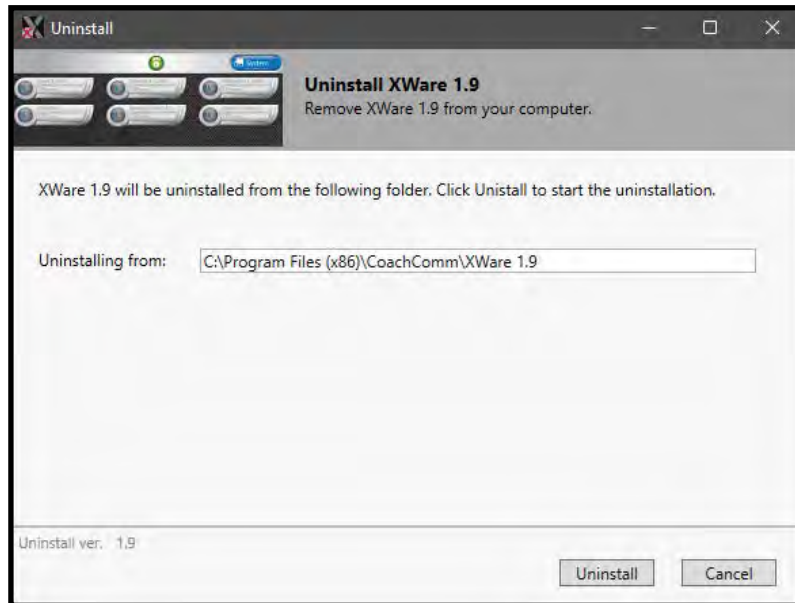

Figure 131: Uninstall Process Screen

4. You will be asked to confirm your decision to “Delete all user files.” Click **Yes**.

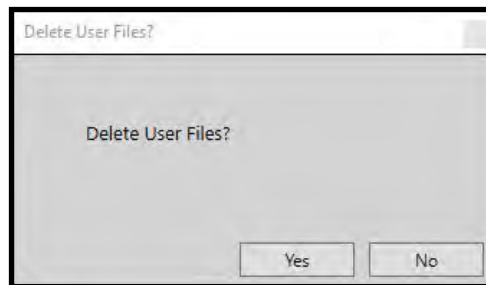

Figure 132: Confirm X-Ware Uninstall Screen

5. The uninstall process will complete. Click **Close**. Verify the original X-Ware folder is now empty. If not, delete any remaining files.
6. Reboot/restart the PC.

Once you’ve uninstalled X-Ware from the cart computer, use the following steps to install an updated version of X-Ware.

1. Download a copy of the latest X-Ware update from the CoachComm website. (You should receive a link to the exact location in the release announcement).
2. Once it is downloaded (likely to your PC’s “Downloads” folder), save the “XWare_Setup_v#.#” file to a removable USB drive.
3. Insert your removable USB drive to your cart’s PC, and double-click on the “XWare_Setup_v#.#” file to run it on the cart PC. An X-Ware installation prompt window will open.

- On the License Agreement screen, click **I Agree**.

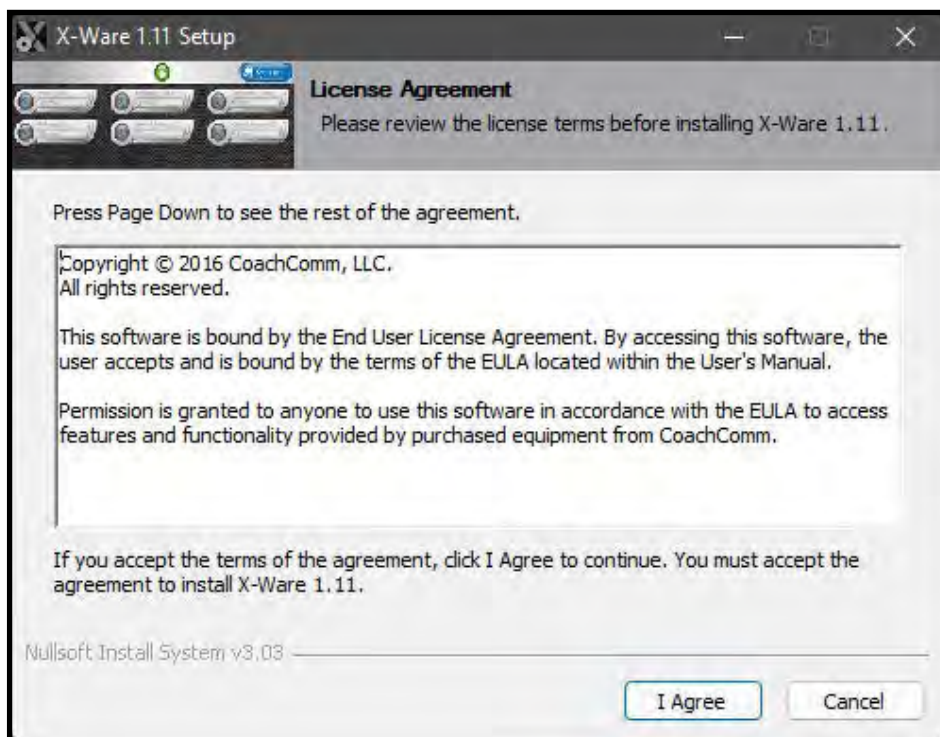

Figure 133: License Agreement Screen

- On the “Install Location” screen, click **Next** to install X-Ware into the default destination folder.

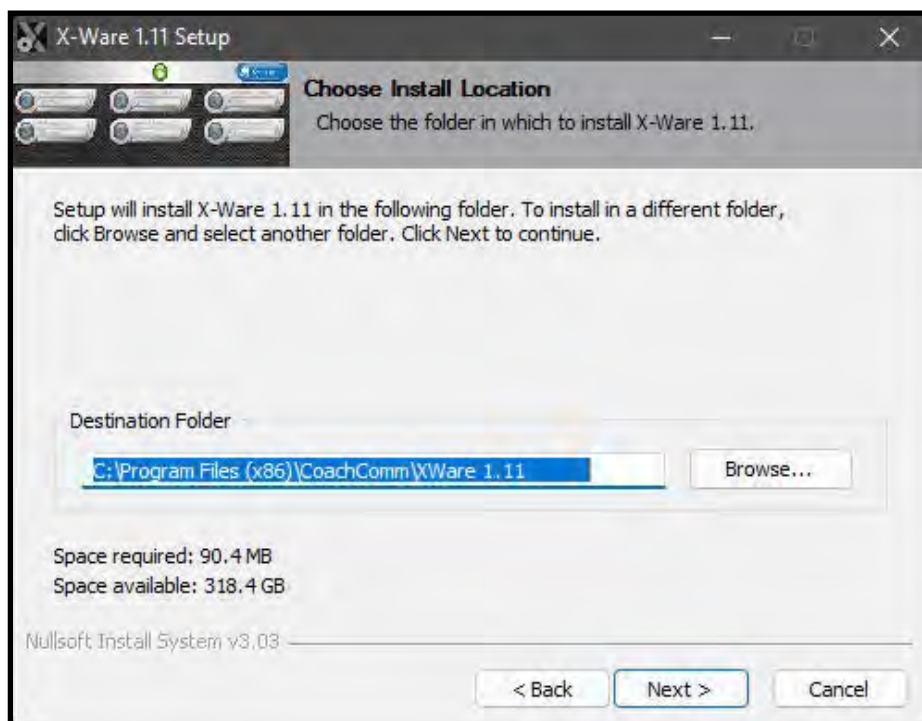

Figure 134: Default X-Ware Destination

- On the “Start Menu Folder” screen, click **Install** to begin install. Installation process will begin and take only a few seconds. Click **Close** when complete.
- An X-Ware icon should have been placed onto the desktop and is ready for use.

Updating Device Firmware

The current firmware package requires connecting devices directly to the PC USB for firmware updates. Update times may vary by device.

IMPORTANT: Always update the top Control Unit (CU) first, followed by your bottom (secondary) CU, then your Radio Transceivers (RTs), and then your Radio Packs (RPs).

IMPORTANT: When updating each CU's firmware to version 1.9, an additional file upload directly to the CU (via front panel USB) will be required. Upon clicking "Scan for Devices" in X-Ware's firmware tab, you will find step-by-step instructions for this process.

IMPORTANT: Always follow any specific firmware update instructions delivered with the new release. Firmware release notes and any separately published update procedures supersede the information provided below.

Prerequisites:

1. Make sure that you have saved a backup copy of your CCF and that the most recent version of X-Ware is installed on the cart PC. See page 86 for more information about how to update X-Ware.

Firmware Update Procedures:

1. Connect the Radio Transceivers (RTs) to the system.
2. Power on the Control Units, select **Home** or **Away** from the CU's LCD, and wait for the configuration (CCF) to load. The empty Home screen will display on the CUs' LCDs. The RTs' LEDs will light to indicate that they are receiving power.

Note: If your system includes a spare RT, you can update it after the rest of the system is updated by connecting it in place of one of the other RTs or by locally powering it with an external power supply. You may leave your RTs on the mounting bracket for their firmware update.

3. Verify that all RPs are powered off and close X-Ware if it is currently open.
4. On your PC, hold down the CTRL key and double-click on the X-Ware icon. Continue holding down the CTRL key until X-Ware's Advanced Settings window opens.
5. Click on the "Firmware" tab. Then, click the "USB Devices" sub-tab.
6. Connect a USB to Micro USB cable from the PC to the top CU (micro end goes into X-Device).

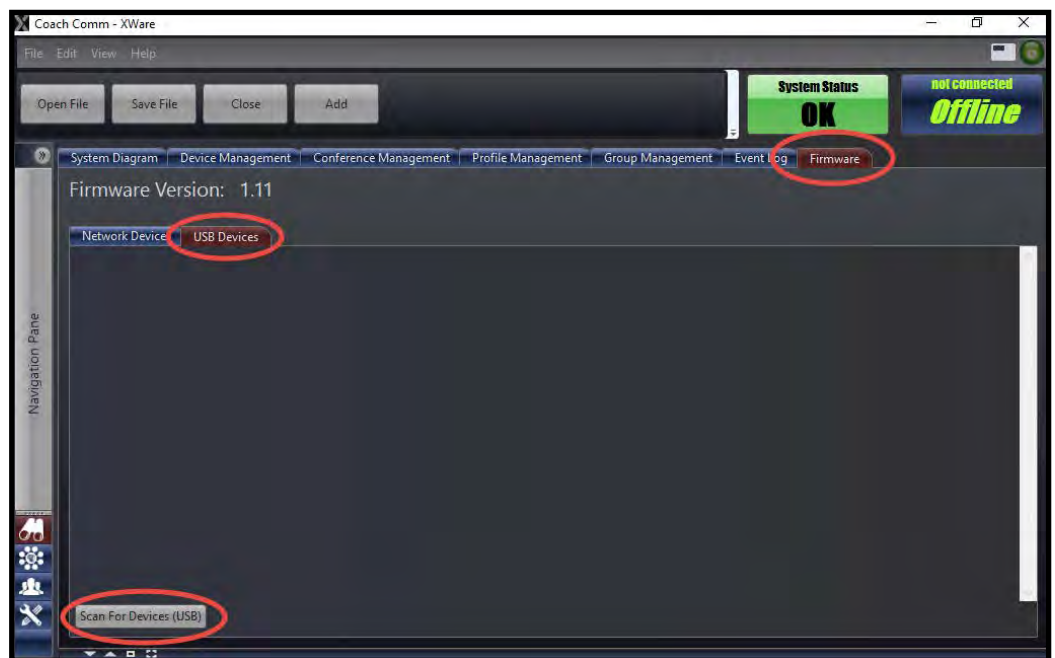

Figure 135: X-Ware Firmware Tab

NOTE: CoachComm recommends updating CUs and RTs one device at a time; however, a powered USB hub may be utilized to connect multiple RPs to your PC to update several at a time. If you are doing this, be sure all RPs are connected prior to Step 7.

7. Click the **Scan For Devices** button at bottom of the tab.
8. Click the **Update** button. A progress bar will display.
9. Wait for the device to complete its update process. DO NOT disconnect the device or click **Abort** until all of the device's updates are complete and an "Update Complete" message displays in the progress bar. Click the **Clear** button to remove that device from the list.

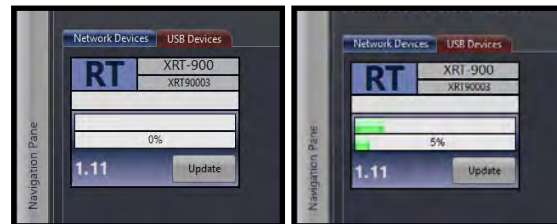

Figure 136: Connected Device

Figure 137: Device Firmware In Progress

Note: When updating CUs, the CUs will reboot; wait for the CU front panel to display an "Upload Complete" message before clearing the X-Ware screen and continuing to Step 11.

Note: When updating RTs, wait for the RX and TX LEDs to finish alternating flashes and return to a normal state before clearing the X-Ware screen and continuing to Step 11. Also, since you should always update the top CU first, both CUs will display a configuration compatibility/firmware mismatch message until the bottom (secondary) CU update is completed.

10. Verify the firmware installation by repeating step 7 to rescan the device. Confirm that the rescanned device now displays the new firmware version number in the software.
11. Disconnect the USB cable from the device without clicking on anything in X-Ware. Once the device is disconnected, click **Clear/Abort** to remove the device from the Firmware tab.
12. Repeat steps 6–11 above until each Control Unit (CU), Radio Transceiver (RT), and Radio Pack (RP) is updated.

Troubleshooting Common Issues

Symptom/s	Potential Problem/s	Corrective Action/s
Failed (WIM) Dry Pair Test	Dry pair/stadium wiring	If audio is present on line in question and quality is good, disregard test failure; if not, switch to new pair.
	Bad patch cable	Replace patch cable.
	“Disable” DPT switch is engaged	Change the switch’s position to enable DPT.
Noise/Static/Hum on System or on a Channel	Dry pair/stadium wiring	Move lines with noise to unused, dry pair.
	Faulty ground plug	Move to another outlet, or apply ground isolation adapter to plug.
	Bad wired accessory such as Wired BeltPack, cable, or headset	Process of elimination: remove items on line in question one at a time until problem disappears.
	Bad WAM thumbwheel	Roll thumbwheel(s) to an unused line.
Crosstalk	Dry pair/stadium wiring	Try a new, unused pair.
	Bad wired accessory such as a Wired BeltPack, cable, or headset	Process of elimination: remove items on combined lines one at a time until crosstalk disappears.
	Bad Sideline or Press Box panel (WIM/WAM)	Isolate to Sideline or Press Box by disconnecting dry pair; remove outside components from system; if still present, contact CoachComm Support.
Red LEDs on 5-Bay Charger	Ambient temperature too high to charge (safety mechanism)	Charge indoors or move chargers to a cooler location.
WIM Backlight Out	No local power at unit	Check power cords or find new outlet.
WIM Text not on Display	Connected dry pair before power up	Disconnect dry pair, power cycle system, re-connect dry pair.
WIM Indicators Flashing	Dry pair/stadium wiring	Try a new, unused pair.
Ringdown Not Working	No power (tone)	Check power supply in rear of Sideline Unit and make sure it has not come unplugged.
	Dry pair/stadium wiring (no ring)	Try a new, unused pair.
Cart Power/Battery Issue	Loose cord connection	Ensure that all cords are properly plugged into the AC Rack Power Strip (vertical power strip inside cart’s rear door) and into the AC Power Distribution Unit (accessible under the 5-Bay Battery Charger drawers).
	If the cart has been stored with the breaker (located in the belly compartment) in the ON position without connection to AC power during that time, the batteries may be too low to power your system.	Contact CoachComm Customer Support at 1.800.749.2761 for assistance if this occurs with your cart.

Product Support

CoachComm support and service personnel are ready to help you with any issues you may have. CoachComm offers product support from 8:00 a.m. to 5:00 p.m. (CST), Monday through Friday. Customers who annually renew their support plan have access to CoachComm's 24/7 after hours support hotline as well. (Access this line by dialing our voice number and following the automated prompts to the After Hours line.) Our company website, www.coachcomm.com, offers supporting product documentation and live chat for help. All questions and/or requests for a Return Material Authorization (RMA) Number should be directed to the Customer Service department:

CoachComm Customer Service Department
Voice: 1.800.749.2761
Fax: 1.888.329.2658
Email: customer.service@coachcomm.com

Returning Equipment for Repair or Maintenance

Do not return any equipment directly to the factory without first obtaining a Return Material Authorization (RMA) Number. Obtaining a Return Material Authorization Number will ensure that your equipment is handled promptly.

All shipments of CoachComm products should be made via UPS, or the best available shipper, prepaid and insured. The equipment should be shipped in the original packing carton; if that is not available, use any suitable container that is rigid and of adequate size to surround the equipment with at least four inches of shock-absorbing material.

Battery Shipping Disclaimer: When shipping equipment to CoachComm that includes batteries, it is the shipper's responsibility to ensure that batteries are properly packaged, labeled, and shipped according to local and international guidelines. "Shipper" is defined as the person or school placing the equipment in the package and offering it to the carrier. Refer to CoachComm's [Lithium-Polymer Battery Shipping Guidelines document](#) on our website for more information.

All shipments should be sent to the following address and must include a Return Material Authorization Number:

CoachComm Customer Service Department
Attn: Return Material Authorization #
205 Technology Parkway
Auburn, AL 36830-0500

License Information

Radio Device License Information

Warning: Changes or modifications to this device not expressly approved by CoachComm could void the user's authority to operate the equipment.

1. FCC Notices

- 1.1. This device complies with Part 15 of the FCC Rules. Operation is subject to the following two conditions: (1) This device may not cause harmful interference, and (2) this device must accept any interference that may cause undesired operation.
- 1.2. This equipment has been tested and found to comply with the limits for a Class A digital device, pursuant to part 15 of the FCC rules. These limits are designed to provide reasonable protection against harmful interference when the equipment is operated in a commercial environment. This equipment generates, uses, and can radiate radio frequency energy and, if not installed and used in accordance with the instruction manual, may cause harmful interference to radio communications. Operation of this equipment in a residential area is likely to cause harmful interference in which case the user will be required to correct the interference at his own expense.

2. Canada, Industry Canada (IC) Notices

- 2.1. This Class A digital apparatus complies with Canadian ICES-003.

Cet appareil numérique de la classe A est conforme à la norme NMB-003 du Canada.

- 2.2. Under Industry Canada regulations, this radio transmitter may only operate using an antenna of a type and maximum (or lesser) gain approved for the transmitter by Industry Canada. To reduce potential radio interference to other users, the antenna type and its gain should be so chosen that the equivalent isotropically radiated power (e.i.r.p.) is not more than that necessary for successful communication.

Conformément à la réglementation d'Industrie Canada, le présent émetteur radio peut fonctionner avec une antenne d'un type et d'un gain maximal (ou inférieur) approuvé pour l'émetteur par Industrie Canada. Dans le but de réduire les risques de brouillage radioélectrique à l'intention des autres utilisateurs, il faut choisir le type d'antenne et son gain de sorte que la puissance isotrope rayonnée équivalente (p.i.r.e.) ne dépasse pas l'intensité nécessaire à l'établissement d'une communication satisfaisante.

- 2.3. This radio transmitter (FCCID: 2AX9C-CCT24 & 2AX9C-CCT900, IC: 30796-CCT24 & 30796-CCT900) has been approved by Industry Canada to operate with the antenna types listed below with the maximum permissible gain and required antenna impedance for each antenna type indicated. Antenna types not included in this list, having a gain greater than the maximum gain indicated for that type, are strictly prohibited for use with this device.

Le présent émetteur radio (FCCID: 2AX9C-CCT24 & 2AX9C-CCT900, IC: 30796-CCT24 & 30796-CCT900) a été approuvé par Industrie Canada pour fonctionner avec les types d'antenne énumérés ci-dessous et ayant un gain admissible maximal et l'impédance requise pour chaque type d'antenne. Les types d'antenne non inclus dans cette liste, ou dont le gain est supérieur au gain maximal indiqué, sont strictement interdits pour l'exploitation de l'émetteur.

- 2.4. This device complies with Industry Canada licence-exempt RSS standard(s). Operation is subject to the following two conditions: (1) this device may not cause interference, and (2) this device must accept any interference, including interference that may cause undesired operation of the device.

Le présent appareil est conforme aux CNR d'Industrie Canada applicables aux appareils radio exempts de licence. L'exploitation est autorisée aux deux conditions suivantes : (1) l'appareil ne doit pas produire de brouillage, et (2) l'utilisateur de l'appareil doit accepter tout brouillage radioélectrique subi, même si le brouillage est susceptible d'en compromettre le fonctionnement.

RF-Exposure Statements

Radio Packs

X-System Radio Packs have been designed to be worn and used in close proximity to the human body—what the FCC calls a “portable” use.

This equipment complies with FCC radiation exposure limits set forth for an uncontrolled environment. This equipment is in direct contact with the body of the user under normal operating conditions. This transmitter must not be co-located or operating in conjunction with any other antenna or transmitter.

Radio Transceivers

The X-System Radio Transceiver has been designed for use as what the FCC calls a “mobile” device.

This equipment complies with FCC radiation exposure limits set forth for an uncontrolled environment. This equipment should be installed and operated with minimum distance 20 cm (7.87 in.) between the radiator and your body. This transmitter must not be co-located or operating in conjunction with any other antenna or transmitter.

Non-Radio-Device License Information

Warning: Changes or modifications to this device not expressly approved by CoachComm could void the user's authority to operate the equipment.

1. FCC Notices

- 1.1. This device complies with Part 15 of the FCC Rules. Operation is subject to the following two conditions: (1) This device may not cause harmful interference, and (2) this device must accept any interference that may cause undesired operation.
- 1.2. This equipment has been tested and found to comply with the limits for a Class A digital device, pursuant to part 15 of the FCC rules. These limits are designed to provide reasonable protection against harmful interference when the equipment is operated in a commercial environment. This equipment generates, uses, and can radiate radio frequency energy and, if not installed and used in accordance with the instruction manual, may cause harmful interference to radio communications. Operation of this equipment in a residential area is likely to cause harmful interference in which case the user will be required to correct the interference at his own expense.

1. Canada, Industry Canada (IC) Notices

- 1.3. This Class A digital apparatus meets all requirements of the Canadian Interference Causing Equipment Regulations.

Cet appareillage numérique de la classe A répond à toutes les exigences de l'interférence canadienne causant des règlements d'équipement.

X-Ware™ End User License Agreement (EULA)

This End-User License Agreement (the “EULA”) is a legal agreement between you (the “Licensee”), an individual, and CoachComm, LLC (the “Company”), the author of X-Ware (the “Software”), including the deliverables provided pursuant to this EULA, which may include data files, scripts, programs, associated media, printed materials, “online” or electronic documentation.

By installing, copying, or otherwise using the Software, Licensee agrees to be bound by the terms and conditions set forth in this EULA. If Licensee does not agree to the terms and conditions set forth in this EULA, then Licensee may not download, install, or use Software.

Please read this EULA agreement carefully before completing the installation process and using X-Ware. It provides a license to use X-Ware and contains warranty information and liability disclaimers.

This EULA agreement shall apply only to the Software supplied by CoachComm, LLC herewith regardless of whether other software is referred to or described herein. The terms also apply to any CoachComm, LLC updates, supplements, Internet-based services, and support services for the Software, unless other terms accompany those items on delivery. If so, those terms apply.

If you are entering into this EULA agreement on behalf of a company or other legal entity, you represent that you have the authority to bind such entity and its affiliates to these terms and conditions. If you do not have such authority or if you do not agree with the terms and conditions of this EULA agreement, do not install or use the Software, and you must not accept this EULA agreement.

License Grant

- A. **Software Product License.** Subject to the terms of this EULA, Company hereby grants to Licensee a royalty-free, non-exclusive, non-transferable license to possess and to use a copy of the Software. Software is being distributed by Company. Licensee is not allowed to make a charge for distributing this Software, either for profit or merely to recover media and distribution costs.
- B. **Installation and Use.** Licensee may install and use an unlimited number of copies of Software on a shared computer or concurrently on different computers, and make multiple back-up copies of Software, solely for Licensee’s use within Licensee’s business or personal use.

Description of Rights and Limitations

- A. **Limitations.** The user shall use X-Ware strictly in accordance with the terms of the related Agreements and shall not (a) decompile, reverse engineer, disassemble, attempt to derive the source code of, or decrypt X-Ware; (b) make any modification, adaptation, improvement, enhancement, translation or derivative work from X-Ware; (c) violate any applicable laws, rules or regulations in connection with the user’s access or use of X-Ware; (d) reproduce, copy, distribute resell, or otherwise use the software for any commercial purpose; (e) use any other proprietary information interfaces of CoachComm or other intellectual property of CoachComm in the design, development, manufacture, licensing, or distribution of any applications or devices for use with X-Ware.
- B. **Separation of Components.** Software is licensed as a single product. Its components may not be separated for use on more than one computer.
- C. **Software Transfer.** Licensee may permanently transfer all rights under the EULA, provided recipient agrees to the terms of this EULA.

Intellectual Property

All rights, title, interest, and copyrights in and to the Software, including but not limited to all images, photographs, animations, video, audio, music, text, data, computer code, algorithms, and information, are owned by Company. The Software is protected by all applicable copyright laws and international treaties. Therefore, Licensee is required to treat Software like any other copyrighted material, except as otherwise provided for in this EULA.

- A. **Infringement Acknowledgment.** The user and CoachComm acknowledge and agree that, in the event of a third party claim that X-Ware or the user's possession or use of X-Ware infringes any third party's intellectual property rights, the user (and not CoachComm) will be responsible for the investigation, defense, settlement, and discharge of any such claim of intellectual property infringement. You will, however, promptly notify CoachComm in writing of such a claim.

Modifications to X-Ware

CoachComm reserves the right to modify, suspend, or discontinue, temporarily or permanently, X-Ware or any service to which it connects, with or without notice and without liability to the user.

Termination

CoachComm may, in its sole and absolute discretion, at any time and for any reason, suspend or terminate this License and the rights afforded to the user hereunder with or without prior notice. Furthermore, if the user fails to comply with the terms and conditions of this License, then this License and any rights afforded to the user hereunder shall terminate automatically, without any notice or other action by CoachComm. Upon termination of this License, the user shall cease all use of X-Ware and uninstall X-Ware.

Integration

Both parties agree that this EULA is the complete and exclusive statement of the mutual understanding of the parties and supersedes and cancels all previous written and oral agreements and communications relating to the subject matter of this EULA.

Jurisdiction

This EULA shall be deemed to have been made in, and shall be construed pursuant to the laws of the State of Alabama, without regard to conflicts of laws provisions thereof. Any legal action or proceeding relating to this EULA shall be brought exclusively in courts located in Auburn, Alabama, and each party consents to the jurisdiction thereof. The prevailing party in any action to enforce this EULA shall be entitled to recover costs and expenses including, without limitation, attorneys' fees. This EULA is made within the exclusive jurisdiction of the United States, and its jurisdiction shall supersede any other jurisdiction of either party's election.

Non-Transferable

This EULA is not assignable or transferable by Licensee without the prior written consent of Company; any attempt to do so shall be void. Any notice, report, approval or consent required or permitted hereunder shall be in writing and will be deemed to have been duly given if delivered personally or mailed by first-class, registered or certified mail, postage prepaid to the respective addresses of the parties as set forth herein (or such other address as a party may designate by ten (10) days' notice.

Severability

No failure to exercise, and no delay in exercising, on the part of either party, any privilege, any power or any rights hereunder will operate as a waiver thereof, nor will any single or partial exercise of any right or power hereunder preclude further exercise of any other right hereunder. If any provision of this EULA shall be adjudged by any court of competent jurisdiction to be unenforceable or invalid, that provision shall be limited or eliminated to the minimum extent necessary so that this EULA shall otherwise remain in full force and effect and enforceable.

Disclaimer of Warranties

The user acknowledges and agrees that X-Ware is provided on an “as is” and “as available” basis, and that the user’s use of or reliance upon the application and any third party content and services accessed thereby is at your sole risk and discretion. CoachComm and its affiliates, partners, suppliers, and licensors hereby disclaim any and all representations, warranties, and guaranties regarding X-Ware and third party content and services, whether express, implied, or statutory, and including without limitation, the implied warranties of merchantability, fitness for a particular purpose, and non-infringement. Furthermore, CoachComm and its affiliates, partners, suppliers, and licensors make no warranty that i) the application or third party content and services will meet your requirements; ii) X-Ware or third party content and services will be uninterrupted, accurate, reliable, timely, secure, or error-free; iii) the quality of any products, services, information, or other material accessed or obtained by you through X-Ware will be as represented or meet your expectations; or iv) any errors in X-Ware or third party content and services will be corrected.

Limitation of Liability

Company shall not be liable to Licensee, or any other person or entity claiming through Licensee any loss of profits, income, savings, or any other consequential, incidental, special, punitive, direct or indirect damage, whether arising in contract, tort, warranty, or otherwise. Even if Company has been advised of the possibility of such damages. These limitations shall apply regardless of the essential purpose of any limited remedy. Under no circumstances shall Company’s aggregate liability to Licensee, or any other person or entity claiming through Licensee, exceed the financial amount actually paid by Licensee to Company for the Software.

Warranty Information

Limited Warranty

X-System™ products are warranted to be free from defects in materials and workmanship for a period of one year from the date of sale to the end user.

CoachComm Cobalt™, Tempest®, and CoachComm Connex® systems carry a two-year product warranty.

The purchase of a maintenance and support plan is not a condition of coverage under this limited warranty; however, purchasing a plan does extend a product's warranty for an additional year.

The sole obligation of CoachComm, LLC during the warranty period is to provide, without charge, parts and labor necessary to remedy covered defects appearing in products returned prepaid to CoachComm, LLC. This warranty does not cover any defect, malfunction, or failure caused by circumstances beyond the control of CoachComm, LLC, including but not limited to negligent operation, abuse, accident, failure to follow instructions in this Operating Guide, product misuse, defective or improper associated equipment, product alteration, modification and/or repair not authorized by CoachComm, LLC or shipping damage. Products with their serial numbers removed or effaced are not covered by this warranty.

This limited warranty is the sole and exclusive warranty given with respect to CoachComm, LLC products. It is the responsibility of the user to determine before purchase that this product is suitable for the user's intended purpose.

THE PROVIDED WARRANTIES ARE EXCLUSIVE AND TAKE THE PLACE OF ALL OTHER EXPRESS OR IMPLIED WARRANTIES OR CONDITIONS INCLUDING BUT NOT LIMITED TO WARRANTIES OR CONDITIONS OF MERCHANTABILITY, SATISFACTORY QUALITY, INFRINGEMENT AND FITNESS FOR A PARTICULAR PURPOSE, ALL OF WHICH ARE DISCLAIMED.

Parts Limited Warranty

Replacement parts for CoachComm, LLC products are warranted to be free from defects in materials and workmanship for 120 days from the date of sale to the end user.

This warranty does not cover any defect, malfunction, or failure caused by circumstances beyond the control of CoachComm, LLC, including but not limited to negligent operation, abuse, accident, failure to follow instructions in the Operating Manual, defective or improper associated equipment, attempts at modification and/or repair not authorized by CoachComm, LLC, and shipping damage. Any damage done to a replacement part during its installation voids the warranty of the replacement part.

This limited warranty is the sole and exclusive express warranty given with respect to CoachComm, LLC products. It is the responsibility of the user to determine before purchase that this product is suitable for the user's intended purpose. ANY AND ALL IMPLIED WARRANTIES, INCLUDING THE IMPLIED WARRANTY OF MERCHANTABILITY, ARE LIMITED TO THE DURATION OF THIS EXPRESS LIMITED WARRANTY. NEITHER COACHCOMM, LLC NOR ANY AUTHORIZED RESELLER WHO SELLS COACHCOMM PRODUCTS IS LIABLE FOR INCIDENTAL OR CONSEQUENTIAL DAMAGES OF ANY KIND.

Battery Warranty

CoachComm provides a one-year warranty for all CoachComm branded lithium-polymer rechargeable batteries (one year from the date of sale to and purchase by the end user). The warranty period is based upon the expectation that the battery will deliver 80% of its initial capacity after 300 cycles at typical power loads. Lithium-polymer batteries will continue to operate below 80% capacity threshold; however, the capacity (run time) delivered between charges will continue to decrease. Apart from this warranty, batteries are also covered as part of the customer's annual maintenance plan (where applicable).

Glossary

AudioCom[®] XLR Terminations - See Figure 138.

Balanced Audio - A form of transmitting a wired signal. Balanced systems use two wires for each talk line. The audio is out of phase 180 degrees from one wire to the other. In this way, noise can be filtered out more easily. Balanced audio is usually much less susceptible to hum and interference from long cable runs.

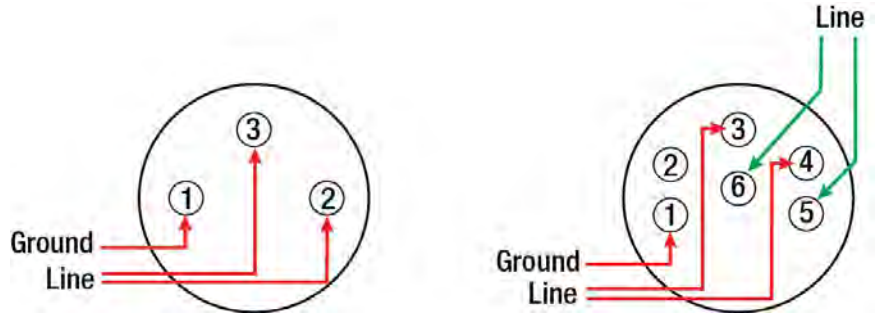

Figure 138: XLR Terminations

Conference - A grouping of audio entities. Wireless Radio Packs may subscribe to one or more conferences.

Dry Pair - A twisted pair of wires, typically connecting between the press box and the sidelines. For the Telex[®] AudioCom[®] system operating from power on one end only, this wire should be 26 gauge or better.

Mic Gain - Increase in the power of the signal from the microphone

Mic Type - Either electret or dynamic, determined by user selection or system auto-detection

Noise Gate - Dynamic processor that suppresses unwanted noise present when the audio signal is at a low level

Profile - A Radio Pack Profile assigns functionality to a Radio Pack's local controls, knobs, and buttons as well as what conferences they subscribe to.

RJ-14 - A telephone jack used to make connections with dry pair. By definition, the RJ-14 has two pair (i.e., four wires). It is often confused with an RJ-11 (two wires). Some phone technicians will call these RJ-11 4 wire jacks. Please note the unique wiring of the RJ-14 for the X-System application in Figure 139.

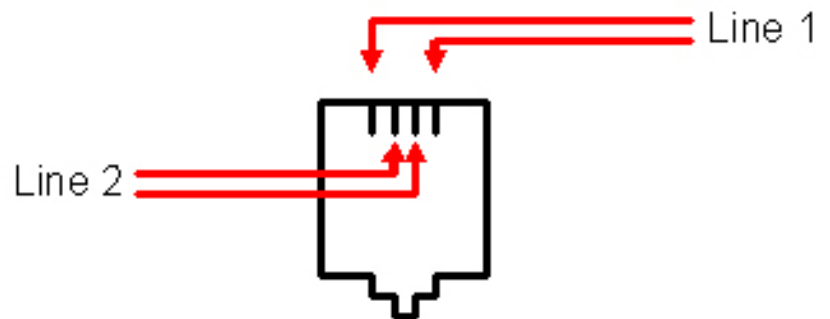

Figure 139: RJ-14 Wiring

Sidetone - The user's own voice folded back into the user's ear. This adjustment allows for a user to hear more or less of his/her own voice in his/her headset. If sidetone is turned down, the user can still hear other users but he/she cannot hear his/her own voice. If the sidetone is turned up too far, the user may cause "feedback" or squealing on his/her intercom line.

Specifications

***Notice About Specifications:** While CoachComm makes every attempt to maintain the accuracy of the information contained in this manual, this information is subject to change without notice. Please check our website for the latest system specifications and certifications.

Sideline Cart Specifications

Some specifications differ between first- and second-generation sideline carts. Carts with a silver top are first-generation carts; those with a black top are second-generation carts.

Specification	Detail
Sideline Cart Length:	72.16 in.
Sideline Cart Width:	33.87 in.
Sideline Cart Height:	First-Generation Cart: 68.44 in. Second-Generation Cart: 67.5 in.
Sideline Cart Weight:	First-Generation Cart: Approx. 1250 lbs. (fully loaded); 765 lbs. (cart only) Second-Generation Cart: Approx. 1185 lbs. (fully loaded); 700 lbs. (cart only)
Ground Clearance:	3.4 in.
Wheelbase:	45.44 in.
Track (Center-to-Center of Wheels):	27.14 in.
Tire Type:	Pneumatic
Tire Size:	4.80/4-8
Power Requirements:	At a minimum, one dedicated 15 amp 120V circuit
Maximum Mast Height (Extended and Mounted on Cart):	18 ft.
Tire Pressure:	(Always follow recommended PSI on side of tire) Kenda Tires: 36 psi (loaded) Load Star Tires: 90 psi (loaded) Carlise Tires: 42 psi (loaded)
Maximum Recommended Towing Speed	3 mph
Inverter/Charger	Inverter: 2000W 120VAC Charger: 3 Stage 24V
Drive System	24V 48A electric transaxle
Battery Bank	2 AGM 12V 130AH batteries connected in series for 24V

Control Unit Specifications

Specification	XCU-44
Hardwired Intercom Audio Channels (per CU)	8 (four 2-wire and four 4-wire)
Active Radio Packs (Normal Mode) (per CU)	18 (18 active Normal Mode Radio Packs requires use of 3 RTs.)
No. of Paired Radio Packs Supported (per CU)	256
USB Ports	(1) USB Type A; (1) Micro USB
Front Panel LCD Display	512 × 128 resolution
Stage Announce and GPO Closures	5 Relays via DA-15
X-Net Ports (supports 2 connections)	(2) RJ-45 for copper; (1) duplex LC for Single Mode Fiber
Sync In Ports (supports 1 connection)	(1) RJ-45 for copper; (1) duplex LC for Single Mode Fiber
2-Wire Intercom Connection	4 channels via XLR 3F with XLR 3M loop (4 ports)
2-Wire Compatibility	Clear-Com, RTS, and AudioCom (Balanced)
4-Wire Intercom Connection	4 ports via RJ-45
Stage Announce Output	XLR 3M, nominal 12 dBu into 600 ohms, balanced, transformer isolated
AUX IN	1/4" (6.35 mm) 3 conductor jack, 17.5 dBu max in, balanced, transformer isolated
AUX OUT	1/4" (6.35 mm) 3 conductor jack, 12 dBu into 600 ohms, balanced, transformer isolated
LAN Port	(1) RJ-45
Power Input/Connector	100–240V ~ 50–60 Hz, 1.8A
Dimensions	1 RU, 19 in. × 1.73in. × 11.68 in. (48.3 cm × 4.4 cm × 29.7 cm) metal enclosure
Weight	6.5 lbs (2.9 kg)
Operating Environment	-20° to 50° C (-4° to 122° F); 10% to 90% Humidity.
Maximum Line Length	Copper 330 ft. (100 m); Fiber 32,800 ft. (10,000 m)
Maximum Altitude	6,562 ft. (2,000 m)
RoHS Compliant	Yes

Wired Pressbox Specifications

Specification	Detail
Height	14 in.
Width	20.5 in.
Depth	17 in.
Weight	Approx. 70 lbs.

Radio Transceiver Specifications

Specification	XRT-900	XRT-2400
RF Frequency (MHz)	902–928 MHz	2400–2483 MHz
RF Scheme	FHSS with TDMA	
Effective Radiated Power	400 mW (+26dBm)	100 mW (+20dBm)
Receiver Sensitivity	-100 dBm at 10 ⁻⁵ BER	
Radio Certification	FCCID: 2AX9C-CCT900 and IC: 30796-CCT900	FCCID: 2AX9C-CCT24 and IC: 30796-CCT24
Transmission Range	650 ft. (200 m) under typical conditions; 1950 ft. (600 m) line of sight (Note: Functional range depends on many variables, including RF signal absorption, reflection, and external interference.)	500 ft. (150 m) under typical conditions; 1500 ft. (450 m) line of sight (Note: Functional range depends on many variables, including RF signal absorption, reflection, and external interference.)
No. of Radio Packs Supported (when RT in Normal Mode)	6	
Number of Antenna Connections per Transceiver	2	
Antenna Connector Type	RP-TNC	
Supplied Antenna	+2dBi Omni-directional (whip)	
X-NET IN Port (supports 1 connection)	(1) RJ-45 for copper; (1) duplex LC for Single Mode Fiber	
RT LOOP Port	(1) RJ-45	
Maximum Line Length	Copper 330 ft. (100 m); Fiber 32,800 ft. (10,000 m)	
Network Power	X-Net RJ-45 only	
External Power	48VDC Power Supply (Sold Separately)	
Dimensions without Antennas	6.30 in. × 7.74 in. × 1.81 in. (16 cm × 19.7 cm × 4.6 cm)	
Weight with Antennas	1.43 lbs (650 g)	
Operating Environment	-20° to 50° C (-4° to 122° F); 10% to 90% Humidity	
Maximum Altitude	6,562 ft. (2,000 m)	
RoHS Compliant	Yes	

Radio Pack Specifications

Specification	XRP-13-900	XRP-13-2400
RF Frequency (MHz)	902–928 MHz	2400–2483 MHz
RF Scheme	FHSS with TDMA	
Effective Radiated Power	400 mW (+26 dBm)	100 mW (+20 dBm)
Receiver Sensitivity	-100 dBm at 10 ⁻⁵ BER	
Radio Certification	FCCID: 2AX9C-CCT900 and IC: 30796-CCT900	FCCID: 2AX9C-CCT24 and IC: 30796-CCT24
Transmission Range	650 ft. (200 m) under typical conditions; 1950 ft. (600 m) line of sight (Note: Functional range depends on many variables, including RF signal absorption, reflection, and external interference.)	500 ft. (150 m) under typical conditions; 1500 ft. (450 m) line of sight (Note: Functional range depends on many variables, including RF signal absorption, reflection, and external interference.)
Audio Dynamic Range	Greater than 90 dB	
Audio Frequency Response	150 Hz–7 kHz	
Conferences	3	
Simultaneous Listen Paths	1	
Volume Knobs	1	
Talk Buttons	1	
Headset Connector	4-pin male XLR	
USB Port	(1) Micro USB	
Microphone Type	Auto Detect or Manual Select; Dynamic or Electret	
LCD Display	280 × 64 resolution	
Antenna (internal)	(2) 2dBi Dipole	
Battery Life, Rechargeable Lithium-Polymer	Greater than 9 hours	Greater than 10 hours
Charging Power Supply	Micro USB; 6W AC wall adapter	
Charge time for Lithium-Polymer Battery	Under 3 hours	
Optional Power	3 Standard AA alkaline batteries	
Battery Life, Alkaline batteries	Approximately 4.5 hours	Approximately 5 hours
Dimensions (inches)	4.5 in. × 4.57 in. × 2.31 in. (11.4 cm × 11.6 cm × 5.9 cm)	
Weight (with Lithium-Polymer battery)	13 oz. (910 g)	
Material	Polycarbonate substrate with thermoplastic elastomer overmold	
Operating Environment	-20° to 50° C (-4° to 122° F); 10% to 90% Humidity. RP Power Adapter is 0 to 40° C (32° to 104° F).	
Maximum Altitude	6,562 ft. (2,000 m)	
RoHS Compliant	Yes	
IP65 Rating	Yes	

Specification	XRP-22-900	XRP-22-2400
RF Frequency (MHz)	902–928 MHz	2400–2483 MHz
RF Scheme	FHSS with TDMA	
Effective Radiated Power	400 mW (+26 dBm)	100 mW (+20 dBm)
Receiver Sensitivity	-100 dBm at 10 ⁻⁵ BER	
Radio Certification	FCCID: 2AX9C-CCT900 and IC: 30796-CCT900	FCCID: 2AX9C-CCT24 and IC: 30796-CCT24
Transmission Range	650 ft. (200 m) under typical conditions; 1950 ft. (600 m) line of sight (Note: Functional range depends on many variables, including RF signal absorption, reflection, and external interference.)	500 ft. (150 m) under typical conditions; 1500 ft. (450 m) line of sight (Note: Functional range depends on many variables, including RF signal absorption, reflection, and external interference.)
Audio Dynamic Range	Greater than 90 dB	
Audio Frequency Response	150 Hz–7 kHz	
Conferences	2	
Simultaneous Listen Paths	True Dual Listen	
Volume Knobs	2	
Talk Buttons	2	
Headset Connector	4-pin male XLR	
USB Port	(1) Micro USB	
Microphone Type	Auto Detect or Manual Select; Dynamic or Electret	
LCD Display	280 × 64 resolution	
Antenna (internal)	(2) 2dBi Dipole	
Battery Life, Rechargeable Lithium-Polymer	Greater than 9 hours	Greater than 10 hours
Charging Power Supply	Micro USB; 6W AC wall adapter	
Charge time for Lithium-Polymer Battery	Under 3 hours	
Optional Power	3 Standard AA alkaline batteries	
Battery Life, Alkaline batteries	Approximately 4.5 hours	Approximately 5 hours
Dimensions (inches)	4.5 in. × 4.57 in. × 2.31 in. (11.4 cm × 11.6 cm × 5.9 cm)	
Weight (with Lithium-Polymer battery)	13 oz. (910 g)	
Material	Polycarbonate substrate with thermoplastic elastomer overmold	
Operating Environment	-20° to 50° C (-4° to 122° F); 10% to 90% Humidity. RP Power Adapter is 0 to 40° C (32° to 104° F).	
Maximum Altitude	6,562 ft. (2,000 m)	
RoHS Compliant	Yes	
IP65 Rating	Yes	

Specification	XRP-44-900	XRP-44-2400
RF Frequency (MHz)	902–928 MHz	2400–2483 MHz
RF Scheme	FHSS with TDMA	
Effective Radiated Power	400 mW (+26 dBm)	100 mW (+20 dBm)
Receiver Sensitivity	-100 dBm at 10 ⁻⁵ BER	
Radio Certification	FCCID: 2AX9C-CCT900 and IC: 30796-CCT900	FCCID: 2AX9C-CCT24 and IC: 30796-CCT24
Transmission Range	650 ft. (200 m) under typical conditions; 1950 ft. (600 m) line of sight (Note: Functional range depends on many variables, including RF signal absorption, reflection, and external interference.)	500 ft. (150 m) under typical conditions; 1500 ft. (450 m) line of sight (Note: Functional range depends on many variables, including RF signal absorption, reflection, and external interference.)
Audio Dynamic Range	Greater than 90 dB	
Audio Frequency Response	150 Hz–7 kHz	
Conferences	4	
Simultaneous Listen Paths	True Quad Listen	
Volume Knobs	4	
Talk Buttons	4	
Headset Connector	4-pin male XLR	
USB Port	(1) Micro USB	
Microphone Type	Auto Detect or Manual Select; Dynamic or Electret	
LCD Display	280 × 64 resolution	
Antenna (internal)	(2) 2dBi Dipole	
Battery Life, Rechargeable Lithium-Polymer	Greater than 9 hours	Greater than 10 hours
Charging Power Supply	Micro USB; 6W AC wall adapter	
Charge time for Lithium-Polymer Battery	Under 3 hours	
Optional Power	3 Standard AA alkaline batteries	
Battery Life, Alkaline batteries	Approximately 4.5 hours	Approximately 5 hours
Dimensions (inches)	4.5 in. × 4.57 in. × 2.31 in. (11.4 cm × 11.6 cm × 5.9 cm)	
Weight (with Lithium-Polymer battery)	13 oz. (910 g)	
Material	Polycarbonate substrate with thermoplastic elastomer overmold	
Operating Environment	-20° to 50° C (-4° to 122° F); 10% to 90% Humidity. RP Power Adapter is 0 to 40° C (32° to 104° F).	
Maximum Altitude	6,562 ft. (2,000 m)	
RoHS Compliant	Yes	
IP65 Rating	Yes	

Note: The following specifications are for optional add-on accessory cases. These products are not described further in this manual.

Sideline Accessory Case Specifications

Specification	Detail
Height	30 in.
Width	40 in.
Depth	25 in.
Weight	Approx. 225 lbs.

Pressbox Accessory Case Specifications

Specification	Detail
Height	30 in.
Width	39 in.
Depth	19 in.
Weight	Approx. 140 lbs. (without PB8); 210 lbs. (with PB8)

Appendix A: Wireless Press Box Unit (WPB1)

Sideline to Wireless Press Box Unit (WPB1) (System Diagram)

Wireless Press Box Unit

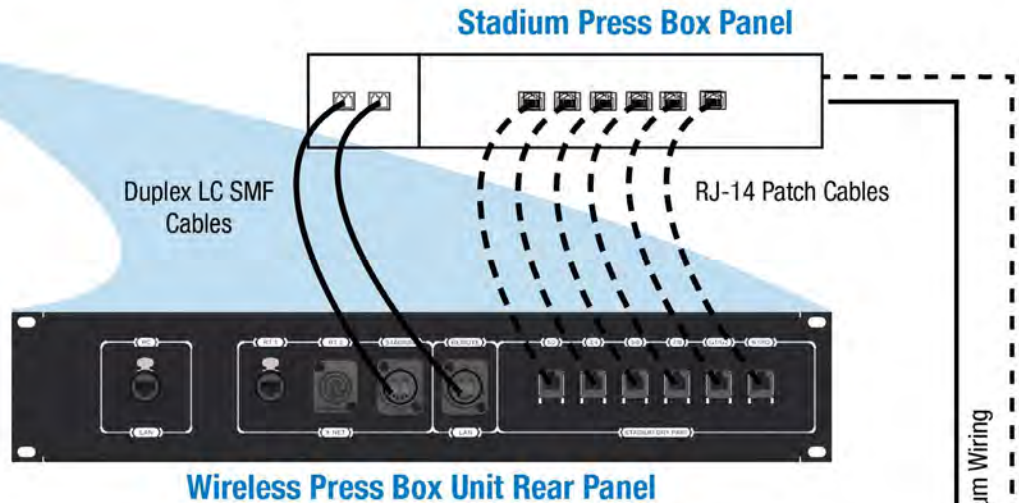

Sideline Cart

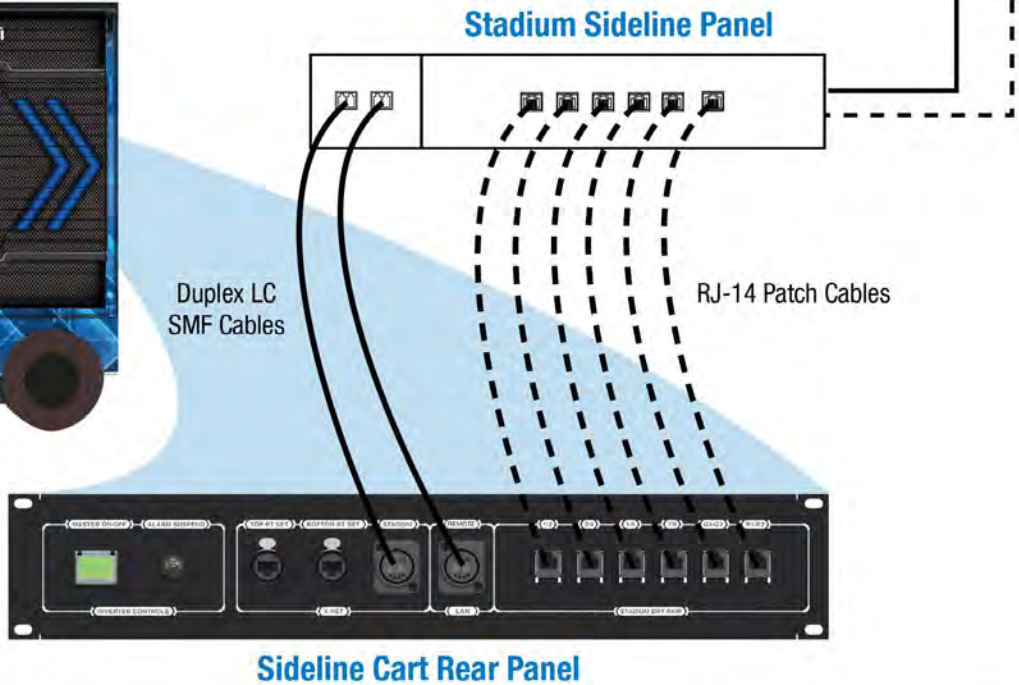

Legend	
(Both shown together in this diagram.)	

Figure 140: X-System Block Diagram with WPB1

Wireless Press Box Unit (WPB1) Block Diagram

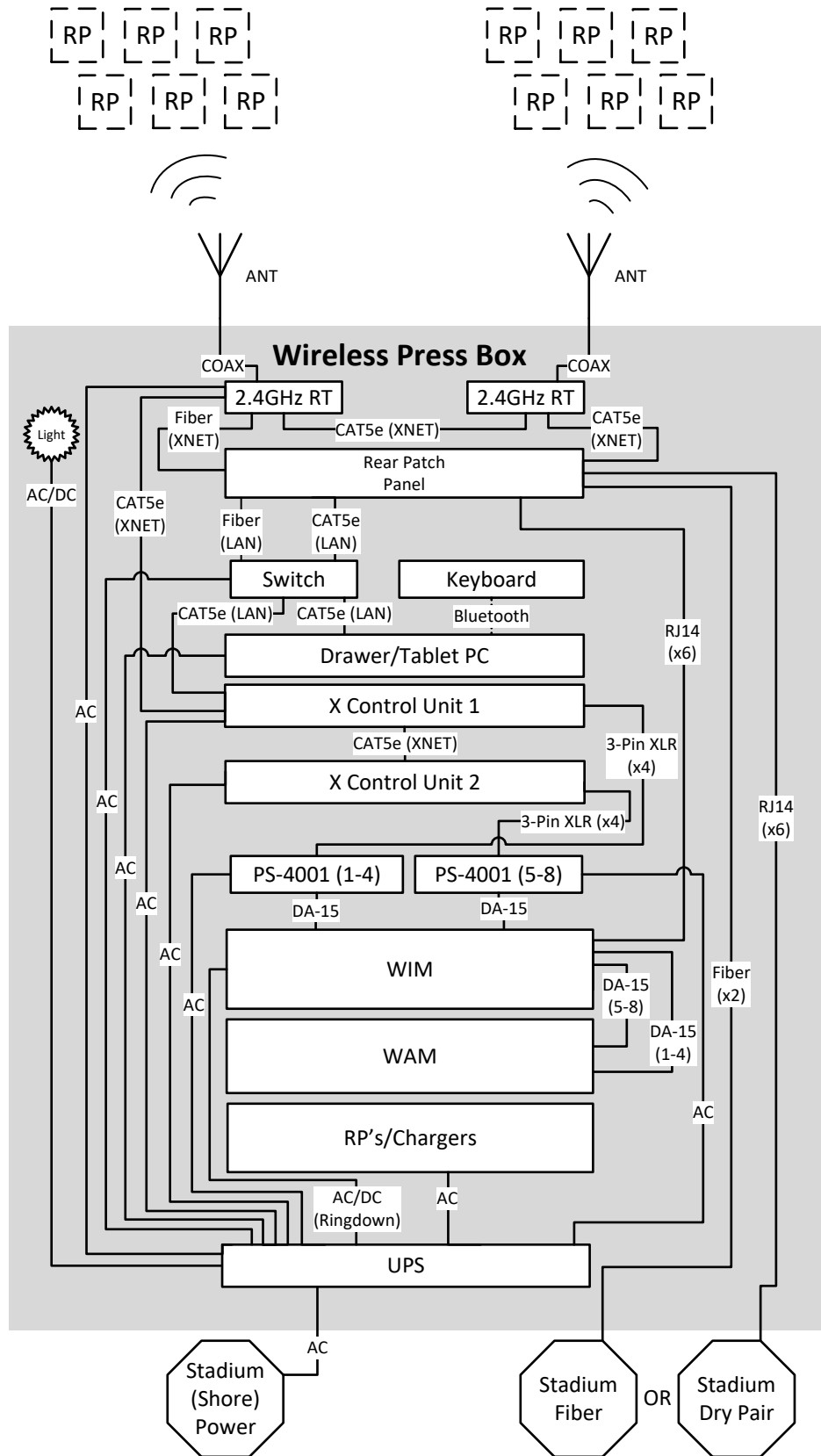

Figure 141: Wireless Press Box Unit (WPB1) Block Diagram

Wireless Press Box Unit (WPB1) Overview

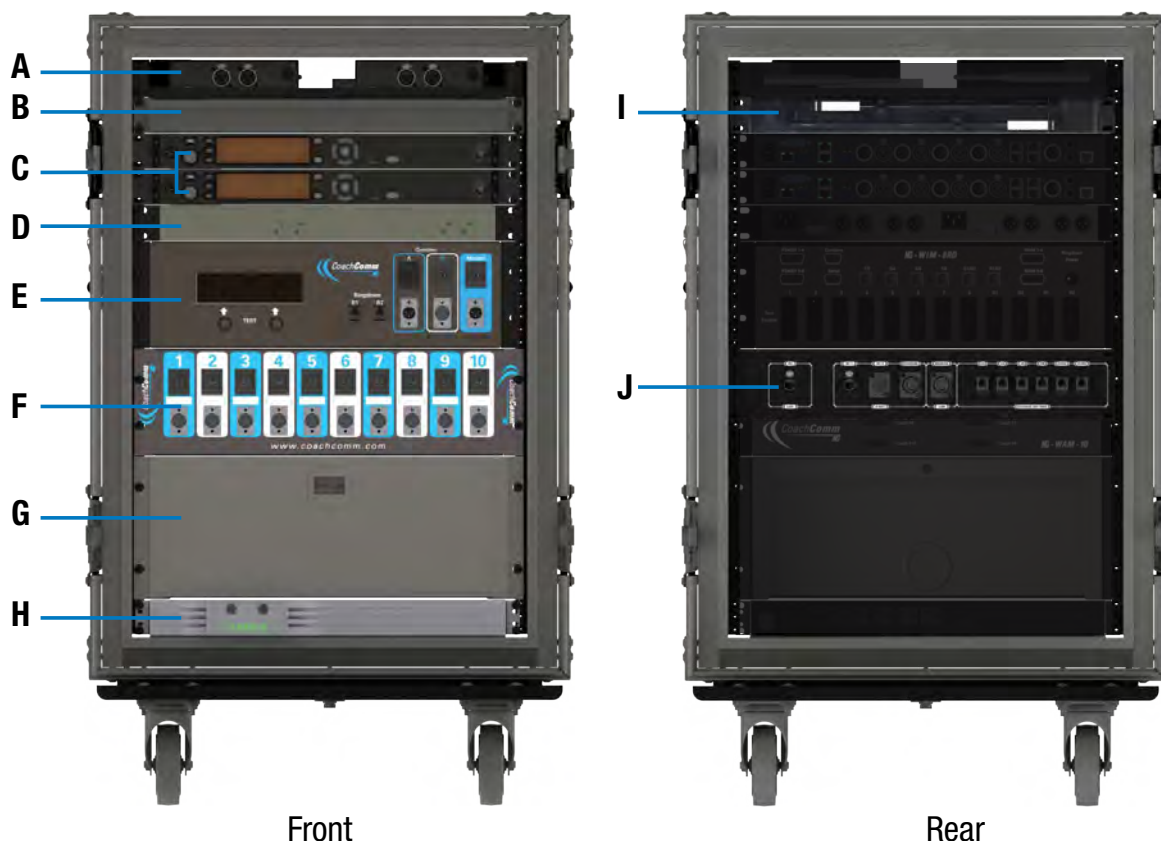

Figure 142: Wireless Press Box Unit (WPB1) Overview

The Wireless Press Box Unit is a trunk that is placed in or near the coach's box. The Wireless Press Box Unit houses its own separate X-System wireless gear, a WAM 10 wired assignment module, a WIM 8 wired interface module, and intercom power supplies. On the inside rear of the unit, connections are available for the dry pair (via spring jacks or RJ-14s) and for the single mode fiber (via LC duplex pair into Neutrik OpticalCon Duo connectors).

The Wireless Press Box provides more customization for booth coaches by using a Radio Pack similar to the field coaches. In addition, it offers the ability to connect to the sideline via fiber optic cabling, which provides remote access to X-Ware as well as a more secure and clearer audio path from the press box to the field.

- A. **X-System RTs** (See page 36 for more information.) These RTs are not removable, they function from within the trunk.
- B. **Tablet PC Drawer**
- C. **X-System Control Unit(s)** (CUs) (See page 34 for more information.)
- D. **PS-4001 AudioCom[®] Power Supply(s)** (See page 30 for more information.)
- E. **Wired Interface Module (WIM)** (See page 25 for more information.)
- F. **Wired Assignment Module (WAM)** (See page 29 for more information.)
- G. **Radio Pack Drawer:** Provides storage for Radio Packs (or 6+6 Drop-In RP and Battery Charger Tray if applicable.)
- H. **Uninterruptible Power Supply (UPS)** (1RU) (See page 30 for more information.)
- I. **LED Work Lights**
- J. **Rear Patch Panel:** Contains LAN, RT, dry pair, and fiber connections (See page 110 for more information.)

Wireless Press Box (WPB1) Rear Patch Panel

The Wireless Press Box Unit's rear patch contains the X-Net connections for RTs, LAN connection, and Stadium Fiber and Dry Pair ports. See the details below about each connection on the panel.

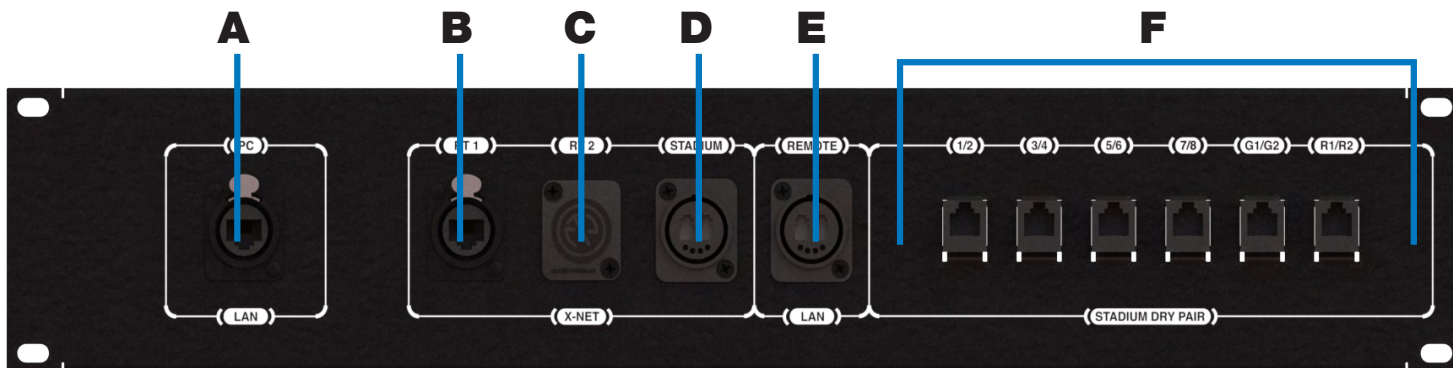

Figure 143: Wireless Press Box (WPB1) Rear Patch Panel

- A. **PC LAN:** Alternate Cat 5e (or greater) connection for the Wireless Press Box Unit's tablet. Disconnect the tablet from its drawer connections and connect a longer cable to this port on the panel if you want to relocate the tablet elsewhere in the press box.
- B. **RT 1:** Cat 5e (or greater) connection for a third, spare RT
- C. **RT 2:** This connection is not currently used with X-System.
- D. **STADIUM:** Duplex LC Neutrik OpticalCon Duo (Part # NO2-4FDW-A) connection for the stadium single mode fiber cable (provides fiber X-Net connection from Wireless Press Box Unit to Sideline Cart)
- E. **REMOTE LAN:** Duplex LC Neutrik OpticalCon Duo (Part # NO2-4FDW-A) connection for the stadium single mode fiber cable (provides fiber LAN connection from Wireless Press Box Unit to Sideline Cart)
- F. **STADIUM DRY PAIR:** Provides the interface between the copper dry pair stadium wiring and X-System via RJ-14s (4-wire RJ)

Using Fiber with Wireless Press Box (WPB1)

Use the following steps to set up and connect your press box system to your sideline system via stadium fiber.

1. Make connections as shown below.

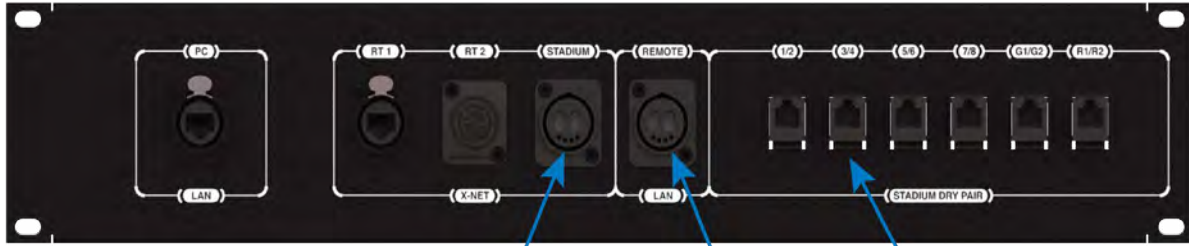

STADIUM:
Fiber for X-Net
from Sideline

REMOTE LAN:
Fiber for X-Ware
PC from Sideline

STADIUM DRY PAIR:
Copper from Sideline
(RJ-14 Ports) for Backup

2. Connect AC power, then do the following:
 - A. Power on the wireless press box unit's Uninterruptible Power Supply (UPS). This will provide necessary power to Press Box Radio Transceivers (RTs) before they are configured.
 - B. Power on the **sideline** Control Units (CUs) if not already on. Select Home or Away and allow the CCF to load. This will configure the Press Box RTs.
 - C. Power on the **press box** CUs. Select Home or Away and allow the CCF to load. **Do not** power these CUs on before the sideline CUs. These CUs, in combination with dry pair stadium wiring, serve as a backup and will be on standby.
 - D. Power on the press box Radio Packs (RPs). Verify that the RPs' log in and their active pairing is to the sideline CU.

Note: Press box RPs should be paired to both the secondary (bottom) sideline CU and the primary (top) press box CU.

Tip: RPs with dual pairing can switch the active pairing between Control Units with this shortcut: hold down both Function buttons for 5 seconds.

3. Connect to X-Ware.
 - A. Power on the press box tablet.
 - B. Launch the screen-sharing software to remotely access the sideline PC.
 - C. Launch the sideline X-Ware (if not already running).
4. Test operation of the press box RPs.
5. CoachComm recommends also connecting, dry-pair testing, nulling, and audio testing your dry-pair RJ-14 connections so they'll be on standby in the event an issue occurs with fiber during the game.
6. You may also connect your wired BeltPacks to the Wired Interface Panel as an additional backup option in the event that wireless communications are disrupted.



Fiber Workflow Reminders:

- Power on the sideline CUs first, then the press box CUs.
- The RPs' active pairing should be to the secondary (bottom) sideline CU.
- X-Ware access will be a remote connection to the sideline system's X-Ware.

Using Dry Pair with Wireless Press Box (WPB1)

Use the following steps to set up and connect your press box system to your sideline system via stadium dry pair connections.

1. Make connections as shown below.

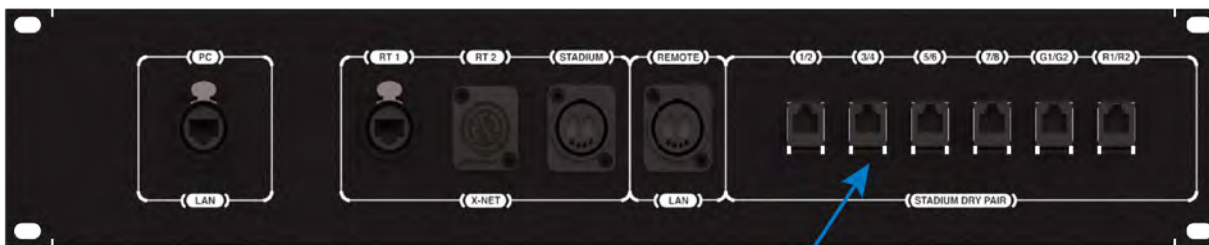

**STADIUM DRY PAIR:
Copper from Sideline (RJ-14 Ports)**

2. Connect AC power for the wireless press box, then do the following:
 - A. Power on the wireless press box unit's Uninterruptible Power Supply (UPS).
 - B. Power on the **press box** Control Units (CUs). Select Home or Away and allow the CCF to load. This will configure the Press Box Radio Transceivers (RTs).
 - C. Power on the press box Radio Packs (RPs). Verify that the RPs' active pairing is to the press box CU.

Note: Press box RPs should be paired to both the secondary (bottom) sideline CU and the primary (top) press box CU.

Tip: RPs with dual pairing can switch the active pairing between Control Units with this shortcut: hold down both Function buttons for 5 seconds.

3. Connect to X-Ware.
 - A. Power on the press box tablet.
 - B. Launch the press box X-Ware.
4. Access each CU's menu (Wired Settings > Intercom Settings) and verify that all 2-Wire ports are set to AudioCom ("A-C").
5. If desired, connect your backup wired BeltPacks for all users to the Wired Interface Panel.
 - A. Power on wired BeltPacks and make sure TALK buttons are off.
6. Perform the dry pair test and auto-null all of the lines from the press box using X-Ware's Conference view (under the System Settings menu).

Dry Pair Workflow Reminders:

- The Press Box CUs will be turned on and will configure the Press Box RTs.
- The RPs' active pairing should be to the primary (top) press box CU.
- X-Ware will control the press box CUs, and it will operate separately from the sideline system's X-Ware.

IMPORTANT: Do not auto-null the sideline CUs and press box CUs at the same time.

7. Test operation of the press box RPs.
8. After the game, power off and stow away X-System wireless press box components.

Wireless Press Box (WPB1) Specifications

Specification	Detail
Length:	27.25 in.
Width:	22.25 in.
Height:	38.855 in.
Weight:	Approx. 275 lbs.
Power Requirements:	At a minimum, one dedicated 15 amp 120V circuit

Appendix B: Wireless Press Box Unit (WPB2)

Sideline to Wireless Press Box Unit (WPB2) (System Diagram)

Wireless Press Box Unit (WPB2)

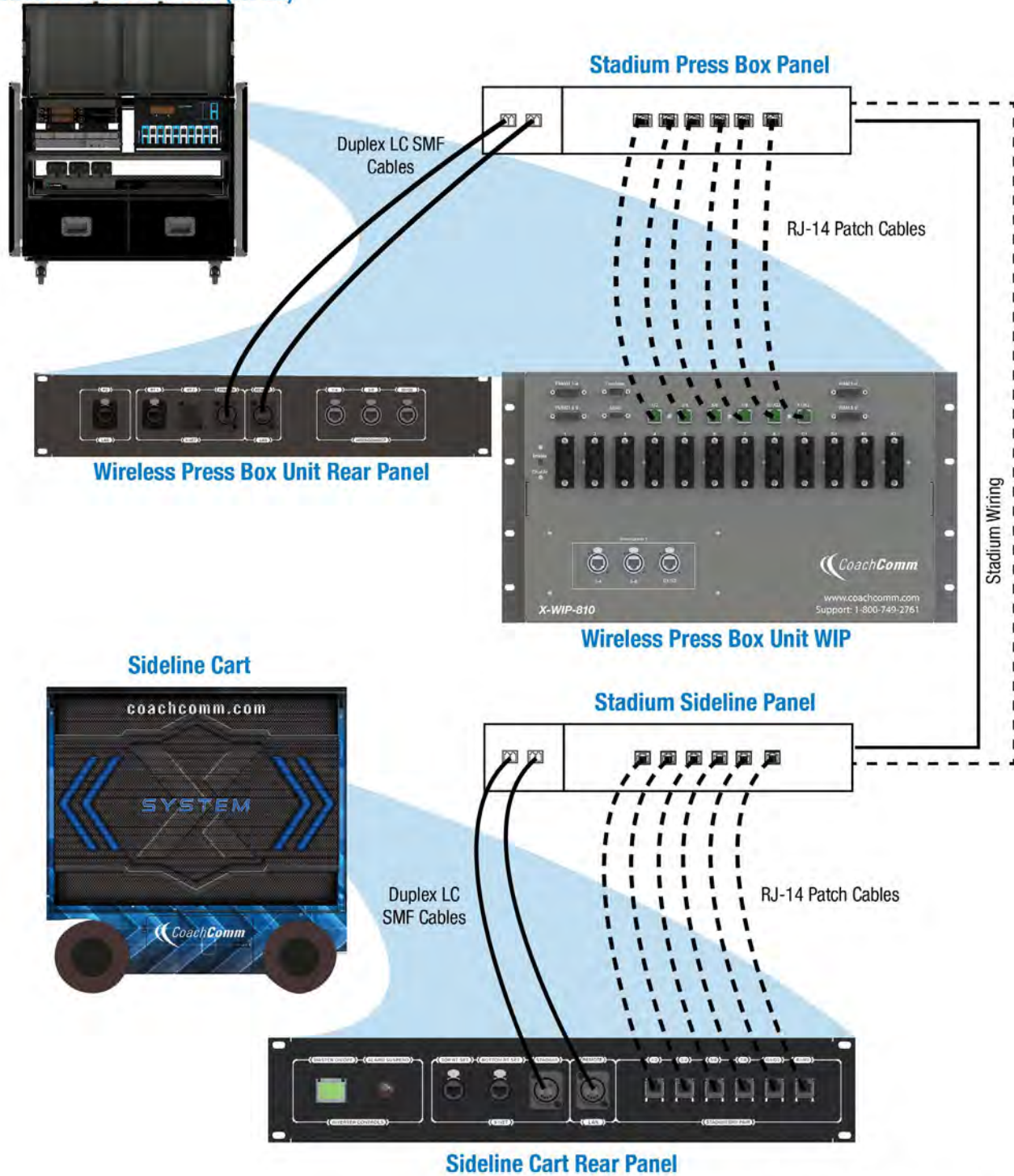

Legend

	Fiber
	Back Up Cat 5 (Copper)
(Both shown together in this diagram.)	

Figure 144: X-System Block Diagram with WPB2

Wireless Press Box Unit (WPB2) Block Diagram

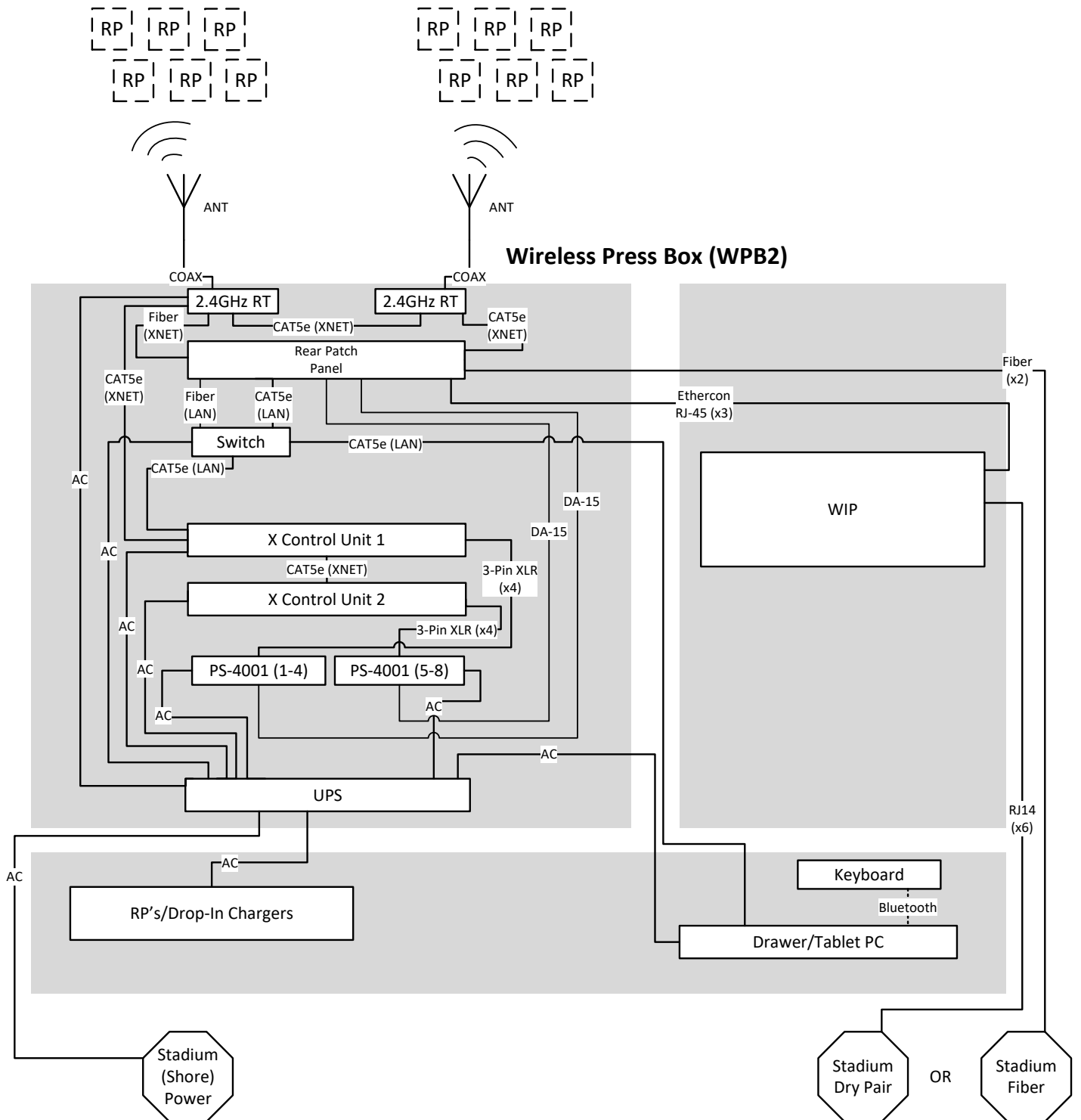

Figure 145: Wireless Press Box Unit (WPB2) Block Diagram

Wireless Press Box Unit (WPB2) Overview

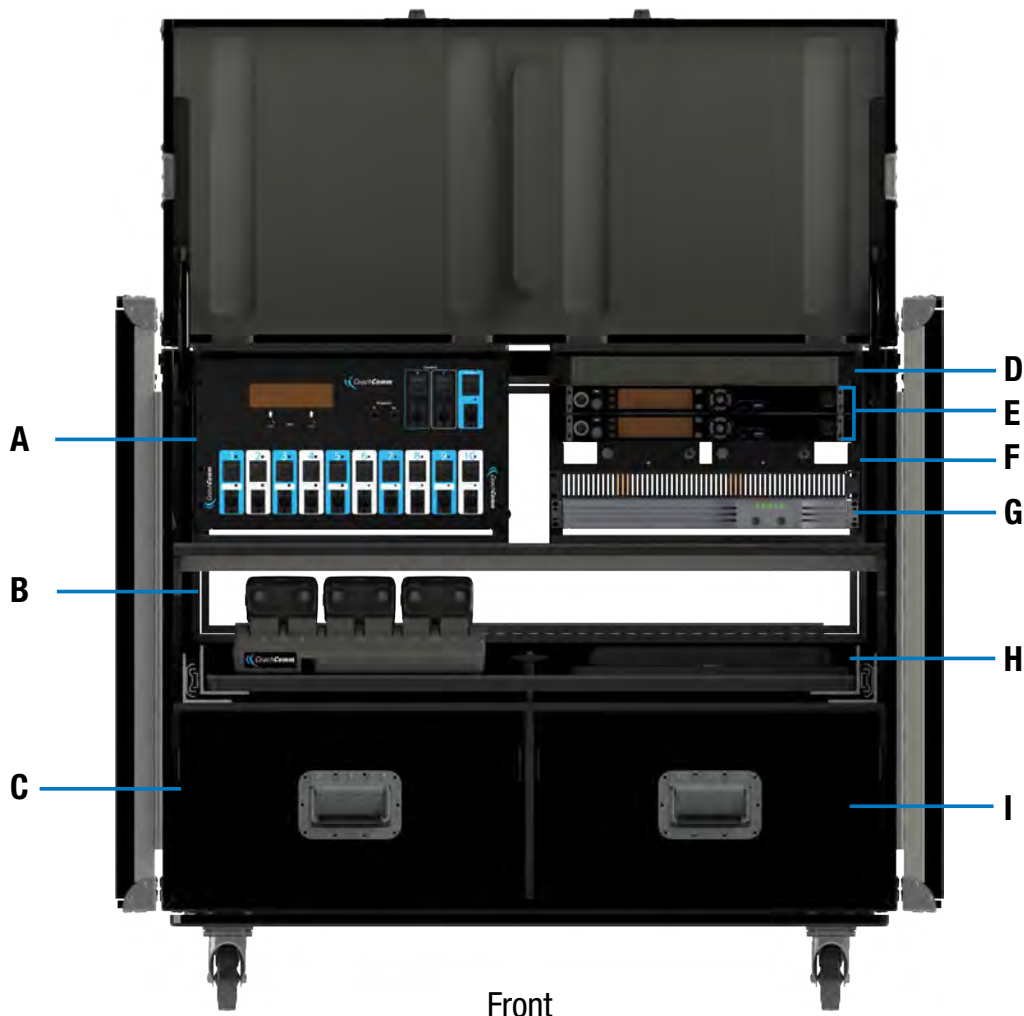

Figure 146: Wireless Press Box Unit (WPB2) Front View

The Wireless Press Box Unit is a trunk that is placed in or near the coach's box. The Wireless Press Box Unit houses its own separate X-System wireless gear, a WAM 10 wired assignment module, a WIM 8 wired interface module, and intercom power supplies. On the inside rear of the unit, connections are available for the dry pair (via spring jacks or RJ-14s) and for the single mode fiber (via LC duplex pair into Neutrik OpticalCon Duo connectors).

The Wireless Press Box provides more customization for booth coaches by using a Radio Pack similar to the field coaches. In addition, it offers the ability to connect to the sideline via fiber optic cabling, which provides remote access to X-Ware as well as a more secure and clearer audio path from the press box to the field.

WPB2 Front

- A. **X-System Wired Interface Panel (WIP)** (See page 119 for more information.)
- B. **6+6 Radio Pack and Battery Chargers Shelf:** Provides storage and charging for Radio Packs and loose batteries
- C. **Radio Pack Drawer:** Provides storage for Radio Packs
- D. **PS-4001 AudioCom® Power Supply(s)** (See page 30 for more information.)
- E. **X-System Control Unit(s) (CUs)** (See page 34 for more information.)

- F. **X-System RTs** (See page 36 for more information.) These RTs are not removable, they function from within the trunk.
- G. **Uninterruptible Power Supply (UPS)** (1RU) (See page 30 for more information.)
- H. **Tablet PC Shelf**
- I. **Headset and Accessory Storage**

WPB2 Rear



Figure 147: Wireless Press Box Unit (WPB2) Rear View

- A. **Rear Patch Panel:** Contains LAN, RT, dry pair, and fiber connections (See page 118 for more information.)
- B. **Shore Power Connection**

Wireless Press Box (WPB2) Rear Patch Panel

The Wireless Press Box Unit's rear patch contains the X-Net connections for RTs, LAN connection, and Stadium Fiber and Dry Pair ports. See the details below about each connection on the panel.

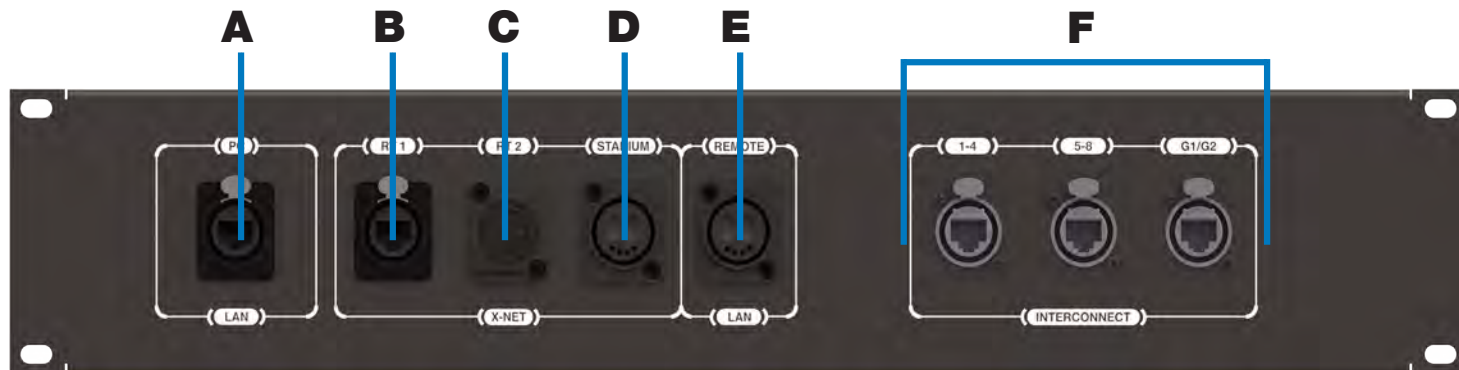

Figure 148: Wireless Press Box (WPB2) Rear Patch Panel

- A. **PC LAN:** Alternate Cat 5e (or greater) connection for the Wireless Press Box Unit's tablet. Disconnect the tablet from its drawer connections and connect a longer cable to this port on the panel if you want to relocate the tablet elsewhere in the press box.
- B. **RT 1:** Cat 5e (or greater) connection for a third, spare RT
- C. **RT 2:** This connection is not currently used with X-System.
- D. **STADIUM:** Duplex LC Neutrik OpticalCon Duo (Part # NO2-4FDW-A) connection for the stadium single mode fiber cable (provides fiber X-Net connection from Wireless Press Box Unit to Sideline Cart)
- E. **REMOTE LAN:** Duplex LC Neutrik OpticalCon Duo (Part # NO2-4FDW-A) connection for the stadium single mode fiber cable (provides fiber LAN connection from Wireless Press Box Unit to Sideline Cart)
- F. **INTERCONNECT:** Provides the interface between the Wired Interface Panel (WIP) and Wireless Press Box Unit's PS4001s via Cat-5e or greater cable

Wired Interface Panel (WIP)

The Wireless Press Box Unit (WPB2) has one Wired Interface Panel (WIP), which is a rack unit that combines the functions of the WIM and WAM.

Overview

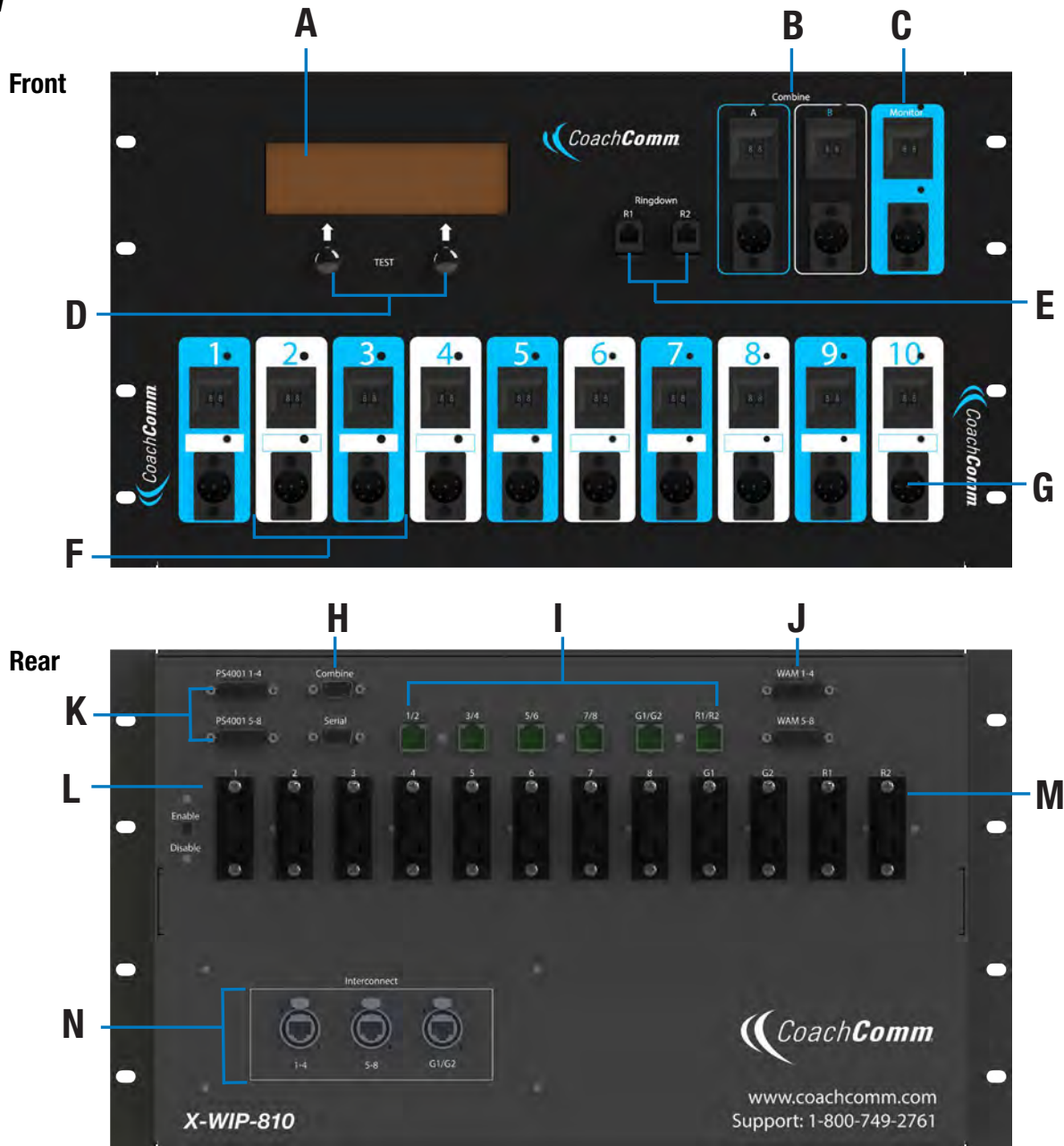

Figure 149: WIP Overview

- A. LCD
- B. Flexible Combine Modules — FCM (2)
- C. Monitor Port
- D. User “soft buttons,” function indicated on LCD
- E. Ringdown instrument connections
- F. Dual Assignment Thumbwheels (1 through 10)
- G. Wired back up ports, 6 pin XLR, two line (1 through 10)
- H. Combine
- I. Dry pair connections, RJ-14s
- J. Connections to WAM 10
- K. Connections to local PS 4001 power supply(s)
- L. Test Enable Switch
- M. Dry pair connections, Spring Jacks
- N. Interconnect to PS-4001 power supplies, Ethercon

Note: Combine and Serial Ports are not used with system operation.

WIP Integrated Dry Pair Tester (DPT)

Refer to “WIM 8 (RD) Integrated Dry Pair Tester (DPT)” on page 27.

WIP Screens

Refer to “WIM 8 (RD) Screens” on page 27.

Flexible Combine Module (FCM)

Refer to “Flexible Combine Module (FCM)” on page 28.

Ringdown Circuits

Refer to “Ringdown Circuits” on page 28.

Using Fiber with Wireless Press Box (WPB2)

Use the following steps to set up and connect your press box system to your sideline system via stadium fiber.

1. Make connections as shown below.

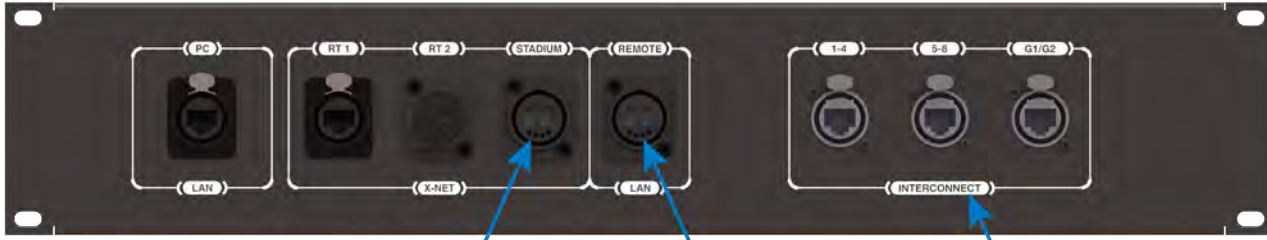

STADIUM:
Fiber for X-Net
from Sideline

REMOTE LAN:
Fiber for X-Ware
PC from Sideline

INTERCONNECT:
CAT-5e (or greater)
from Wired Interface Panel

2. Connect AC power, then do the following:
 - A. Power on the wireless press box unit's Uninterruptible Power Supply (UPS). This will provide necessary power to Press Box Radio Transceivers (RTs) before they are configured.
 - B. Power on the **sideline** Control Units (CUs) if not already on. Select Home or Away and allow the CCF to load. This will configure the Press Box RTs.
 - C. Power on the **press box** CUs. Select Home or Away and allow the CCF to load. **Do not** power these CUs on before the sideline CUs. These CUs, in combination with dry pair stadium wiring, serve as a backup and will be on standby.
 - D. Power on the press box Radio Packs (RPs). Verify that the RPs' log in and their active pairing is to the sideline CU.

Note: Press box RPs should be paired to both the secondary (bottom) sideline CU and the primary (top) press box CU.

Tip: RPs with dual pairing can switch the active pairing between Control Units with this shortcut: hold down both Function buttons for 5 seconds.

3. Connect to X-Ware.
 - A. Power on the press box tablet.
 - B. Launch the screen-sharing software to remotely access the sideline PC.
 - C. Launch the sideline X-Ware (if not already running).
4. Test operation of the press box RPs.
5. CoachComm recommends also connecting, dry-pair testing, nulling, and audio testing your dry-pair RJ-14 connections so they'll be on standby in the event an issue occurs with fiber during the game.
6. You may also connect your wired BeltPacks to the Wired Interface Panel as an additional backup option in the event that wireless communications are disrupted.
7. After the game, power off and stow away X-System wireless press box components.



Fiber Workflow Reminders:

- Power on the sideline CUs first, then the press box CUs.
- The RPs' active pairing should be to the secondary (bottom) sideline CU.
- X-Ware access will be a remote connection to the sideline system's X-Ware.

Using Dry Pair with Wireless Press Box (WPB2)

Use the following steps to set up and connect your press box system to your sideline system via stadium dry pair connections.

1. Make connections as shown below.

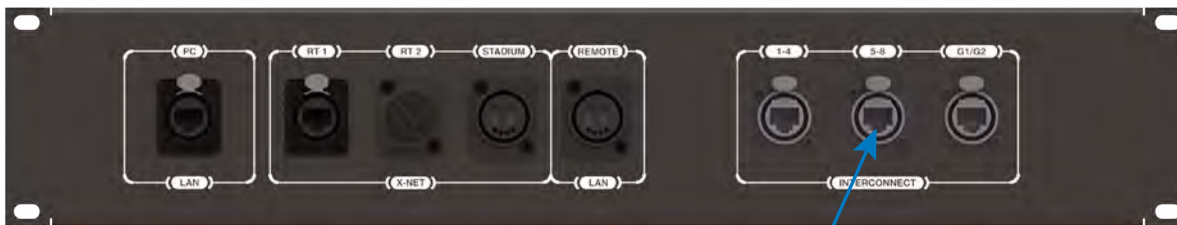

Wireless Press Box Unit (WPB2) Rear Panel

**INTERCONNECT:
CAT-5e (or greater) from
Wired Interface Panel**



Wired Interface Panel Rear

Stadium Dry Pair (RJ-14s)

2. Connect AC power for the wireless press box, then do the following:
 - A. Power on the wireless press box unit's Uninterruptible Power Supply (UPS).
 - B. Power on the **press box** Control Units (CUs). Select Home or Away and allow the CCF to load. This will configure the Press Box Radio Transceivers (RTs).
 - C. Power on the press box Radio Packs (RPs). Verify that the RPs' active pairing is to the press box CU.

Note: Press box RPs should be paired to both the secondary (bottom) sideline CU and the primary (top) press box CU.

Tip: RPs with dual pairing can switch the active pairing between Control Units with this shortcut: hold down both Function buttons for 5 seconds.
3. Connect to X-Ware.
 - A. Power on the press box tablet.
 - B. Launch the press box X-Ware.

4. Access each CU's menu (Wired Settings > Intercom Settings) and verify that all 2-Wire ports are set to AudioCom ("A-C").
5. If desired, connect your backup wired BeltPacks for all users to the Wired Interface Panel.
 - A. Power on wired BeltPacks and make sure TALK buttons are off.
6. Perform the dry pair test and auto-null all of the lines from the press box using X-Ware's Conference view (under the System Settings menu).

IMPORTANT: *Do not auto-null the sideline CUs and press box CUs at the same time.*
7. Test operation of the press box RPs.
8. After the game, power off and stow away X-System wireless press box components.



Dry Pair Workflow Reminders:

- The Press Box CUs will be turned on and will configure the Press Box RTs.
- The RPs' active pairing should be to the primary (top) press box CU.
- X-Ware will control the press box CUs, and it will operate separately from the sideline system's X-Ware.

Wireless Press Box (WPB2) Specifications

Specification	Detail
Length:	22.613 in.
Width:	45.010 in.
Height:	43.625 in.
Weight:	Approx. 500 lbs.
Power Requirements:	At a minimum, one dedicated 15 amp 120V circuit

Appendix C: CoachComm X-System Coach to Player Communication

The Player-worn Radio Pack Module (XRP-CP01-900) or new Mini Module (XRP-CP01M-900) can be added as an upgrade package to the X-System line that will allow for coaches to communicate with players either in a practice or game day environment. Its small size, robust housing, and simple interface allow it to be placed where needed. Integration into the X-System is seamless as software connectivity will allow for full control and routing of audio from coaches to players as needed.

Note: Products and software associated with CoachComm X-System Player and Referee Cutoff are only functional with the CoachComm X-System Player upgrade package.

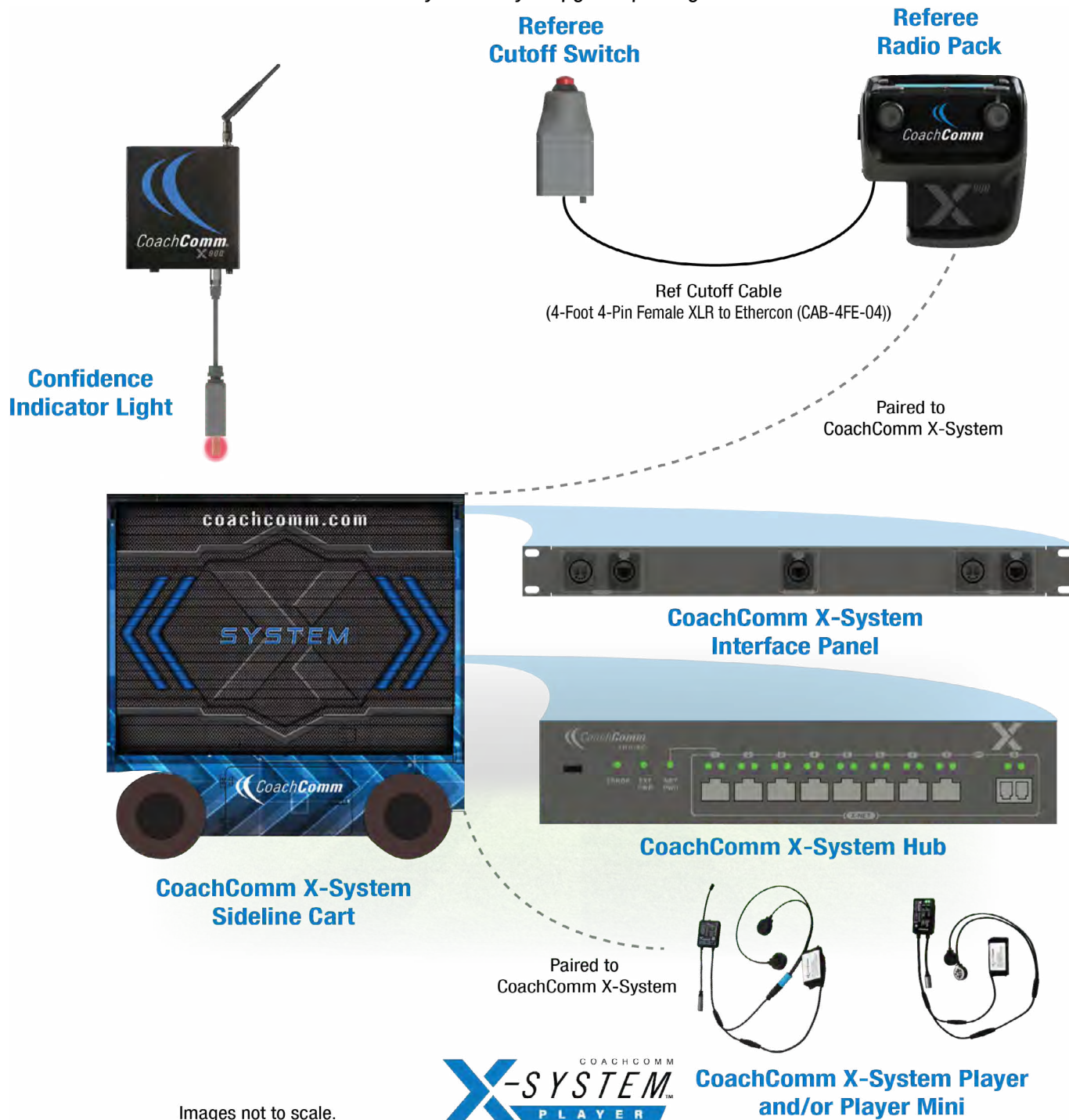

Images not to scale.



Figure 150: CoachComm X-System Player Block Diagram (Single Wireless Referee Cutoff Configuration)

Important Safety Information



WARNING: To prevent SERIOUS INJURY or DEATH, ALWAYS contact the helmet manufacturer for the approved device placement locations for the Radio Pack and its accessories. These may vary between helmet models and between helmet manufacturers.

- » ONLY use with NOCSAE compliant helmets.
- » ONLY use attachments or accessories specifically made for or approved by CoachComm.
- » ALWAYS refer all Radio Pack service to qualified CoachComm service personnel. There are no user serviceable parts inside the Radio Pack.
- » Before installing the Radio Pack and Speaker Assembly in a helmet, turn the volume to its lowest level. Place the Radio Pack and Speaker Assembly into the helmet following the recommendations of the helmet manufacturer for the specific helmet model.



CAUTION: HEARING LOSS HAZARD. To prevent possible permanent hearing loss, ALWAYS set the volume as low as possible depending on the ambient noise at practice or at a game.

- » DO NOT use Radio Pack if it emits any unusual loud noise. Turn Radio Pack off and contact CoachComm Customer Service.
- » Permanent hearing loss may result from exposure to high volumes or other loud noises.



WARNING: FIRE and EXPLOSION HAZARDS. Batteries may explode, may catch fire or cause chemical burns if damaged. To prevent SERIOUS INJURY or DEATH:

- » ALWAYS inspect batteries before use.
- » NEVER use batteries that appear swollen, deformed or damaged, feel hot or emit an unusual smell.
- » DO NOT allow batteries to overheat (reach temperatures of above 140 degrees Fahrenheit (60 degrees Celsius)). Keep batteries out of direct sunlight and away from other heat sources, including open flames.
- » REMOVE helmet immediately if you experience a warming sensation or loss of audio.
- » CoachComm recommends keeping a Class-D fire extinguisher available when charging lithium-polymer batteries. The chemicals inside lithium-polymer batteries are highly flammable.
- » ONLY use batteries approved for use with the Radio Pack. Contact CoachComm for assistance. Use of other batteries may present a risk of fire or explosion and the warranty will be terminated.
- » NEVER leave the batteries unattended while charging. Immediately unplug unit if battery begins to swell or emit smoke while charging. If battery bursts or chemicals begin to leak out of battery housing, the chemicals will react with the air and may result in a fire.
- » NEVER use a damaged charger.



CAUTION: California Prop 65

- » Lithium-ion batteries and products that contain lithium-ion batteries can expose you to chemicals including cobalt lithium nickel oxide, chromium and nickel, which are known to the State of California to cause cancer and birth defects or other reproductive harm. For more information, go to www.P65Warnings.ca.gov

CoachComm X-System Player Module

Components

- A. Coach/Player Radio Pack Module
- B. USB-C Charging/Pairing Port
- C. Speaker Assembly
- D. Rechargeable (LiPoly) Battery

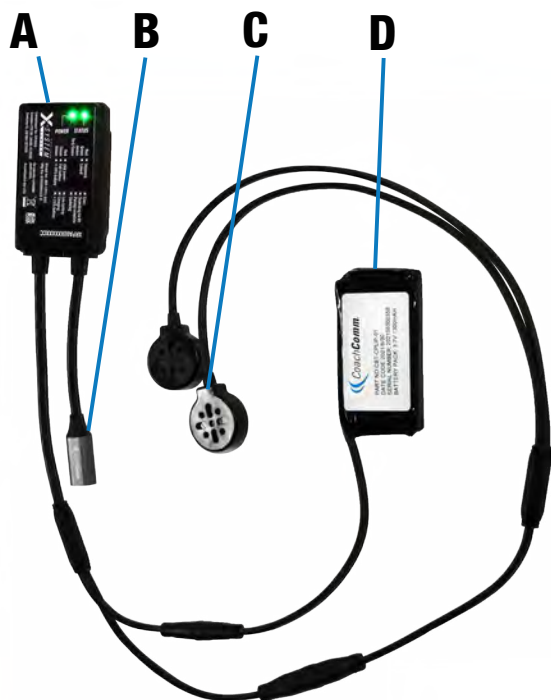

Figure 151: CoachComm X-System Player



Figure 152: CoachComm X-System Player Mini

LED Power and Status Indicators

Indicator	State	Description	Details
Status	Green	Linked	Device is actively logged into a Radio Transceiver.
	Flashing Green	Searching for RT	Device is searching for a Radio Transceiver.
	Red	Unpaired	Device is not paired to a Control Unit. No profile found.
	Flashing Red	Error	Device is in an error state. Please contact CoachComm support.
	Flashing Amber	Pairing Complete	Device was successfully paired to a Control Unit.
	Red/Green Flashing	Updating	Device is receiving a firmware update or a profile update.
Power	Green	Full Battery	Battery charging is complete (while plugged in) or the battery is more than 50% full (while on battery power).
	Flashing Green	Charging	Battery is actively charging.
	Red	USB Power	Device powered by USB; no battery is detected.
	Flashing Red	Low Battery	Low Battery. Less than 15 minutes of run-time remaining.
	Amber	< 50% Battery	Battery has less than 50% life remaining.
	Flashing Amber	< 25% Battery	Battery has less than 25% life remaining.
	Flash every 30sec	Sleep	Device is in low power mode. Shake for 3 seconds to turn on.

CoachComm X-System Player Setup

Contact CoachComm Customer Service for assistance setting up CoachComm X-System Player modules with X-System.

Adding a Player Conference

See “Adding a Conference” on page 68 for information on how to add a conference in X-Ware.

1. Create and name a new player conference.
2. CoachComm recommends enabling High Density mode if a large number of player modules will be paired to the X-System.

PLAYER D	PLAY D	<input checked="" type="checkbox"/>	Call	Mic Kill
PLAYER O	PLAY O	<input checked="" type="checkbox"/>	Call	Mic Kill

Figure 153: Player Conference Examples

Coach Profile Modifications

Assign the player conference to a Talk button on the RP Profile and/or a function button. See “Adding a Profile” on page 69 and “Editing or Cloning Profiles” on page 70 for information on how to add and edit a profile in X-Ware.

Note: Only XRP-13s support coach to player communications. XRP-22 and XRP-44 do not support coach to player communication using the function buttons, but the Talk buttons can be assigned to a player conference. The function button options below will not be available when the conference is assigned a Talk button.

The screenshot shows the 'Profile Management' interface for a profile named 'Coach Jackson'. It displays several configuration sections:

- Conference A:** Conf: OFFENSE, Button Mode: AlwaysOn. Min Vol: 10, Max Vol: 20.
- Conference B:** Conf: PLAYER O, Button Mode: AlwaysOn. Min Vol: 10, Max Vol: 20. This section is highlighted with a red box.
- Conference C:** Conf: SPECIAL TEAMS, Button Mode: Momentary, Audio Overlay: Off. Min Vol: 10, Max Vol: 20.
- Function Button 1:** Function: C2PMix, Button Mode: Disable. Conference Assignment: PLAYER O. This section is also highlighted with a red box.
- Function Button 2:** Function: None, Button Mode: Disable.

Figure 154: Coach RP Profile Player Conferences Assigned to Talk Button and Function Button

Follow the steps below to assign the player conference to a function button:

1. Under Function, select one of three coach to player options for the function button.



Figure 155: Coach RP Profile Function Options

Coach/Player Isolated Talk: Only coaches and player modules on the player conference can hear the speaker when the function button is pressed, and the speaker can hear other RPs from the active conference at the RP's volume level.

Coach/Player Mix: The speaker's audio is sent to both the player and active conferences simultaneously while still listening to the active conference at the RP's volume level.

Coach/Player Switch: Only coaches and player modules on the player conference can hear the speaker when the function button is pressed, and the speaker can only hear other RPs on the player conference at the RP's volume level.

2. The Conference Assignment Selection will appear once the Function is chosen. Select a player conference.
3. Select a Button Mode for the function button (Always On is not available as a Button Mode for coach to player communications).

Adding a Player Profile

See "Adding a Profile" on page 69 for information on how to add a profile in X-Ware.

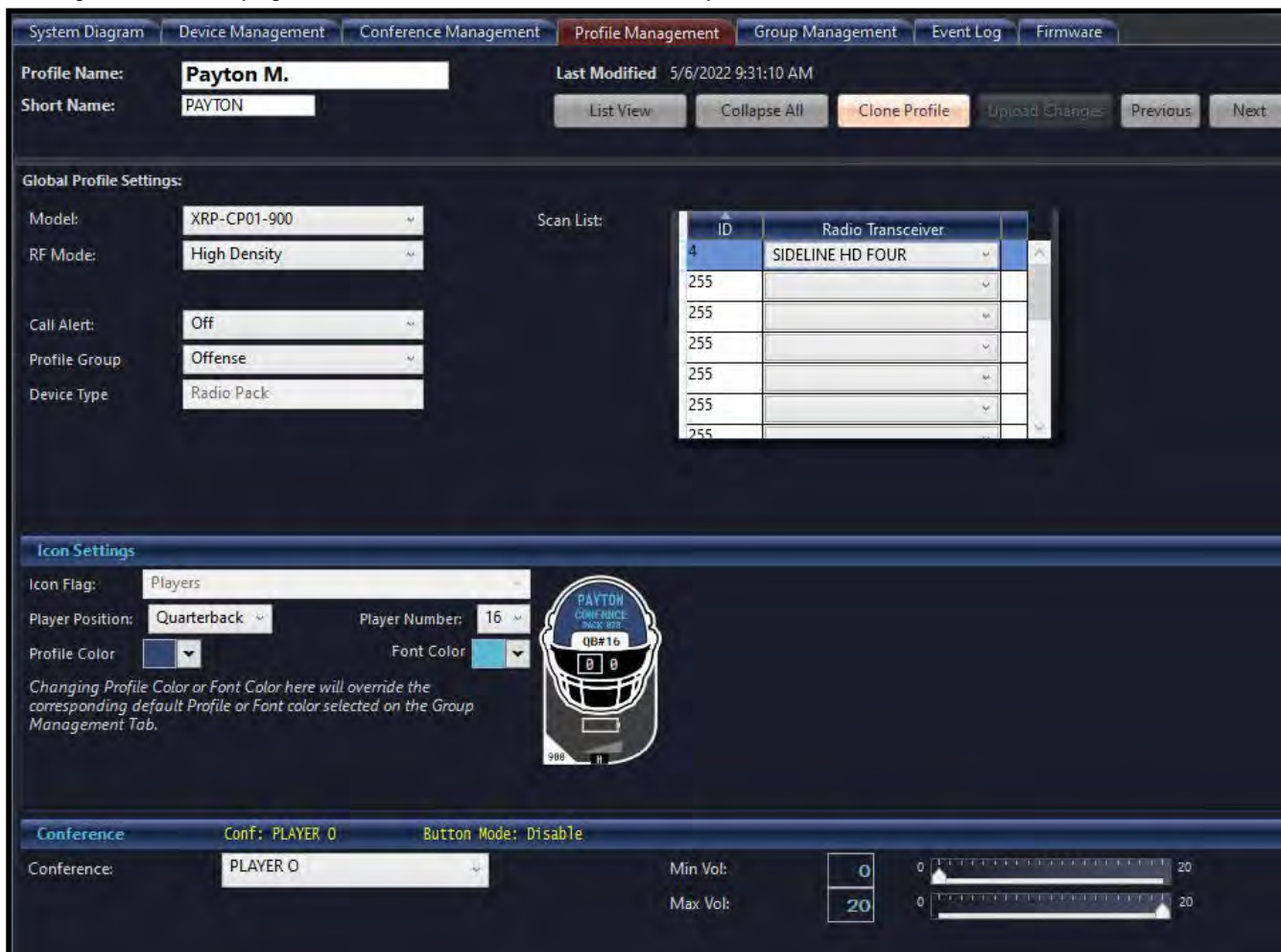

Figure 156: CoachComm X-System Player Profile Example

1. Select XRP-CP01-900 as the model (use this same selection for the XRP-CP01M-900 mini player module).
2. Set the RF Mode to either Normal or High Density mode (CoachComm recommends High Density mode if a large number of player modules will be paired to the X-System).
3. Customize the Player Position and Number in the Icon Settings. See Figure 156 for an example of an CoachComm X-System Player Profile.
4. Select the Player Conference.

See “Assign Profiles from the Control Unit” on page 82 and “Assigning New Profiles” on page 60 for information on assigning this profile to the CoachComm X-System Player packs (if not selected when pairing in the next section).

Pair with X-System

1. Connect to bottom CU. Using the supplied USB-C to USB-A cable, plug the cable into the USB-C connector on the CoachComm X-System Player and into the USB-A connector on the bottom CU.
2. Follow CU prompts. Follow the normal pairing procedure on the LCD screen of the CU. Choose a profile from the list by scrolling left/right, then enter. When paired, the display will read “Pairing complete.”



Figure 157: Select Player Profile on CU

Note: The STATUS LED on the CoachComm X-System Player will flash AMBER when pairing is complete. If the STATUS LED is RED, the X-System Player is not paired.

Coach Radio Pack Operation

On a coach RP, press the Function/Talk button that is assigned to the player conference. Audio will be sent to only those player modules and coach RPs with the player conference assigned.

CoachComm X-System Player Operation

Charge and Power On

1. Connect battery to CoachComm X-System Player. Make sure the arrows on the two connector ends are aligned.
2. Connect CoachComm X-System Player to charger. With the supplied USB Charger and USB-A to USB-C cable, connect to the Charging Connector on the CoachComm X-System Player. The POWER LED will be flashing green during charging and green when fully charged.

Note: The battery cannot be charged without being connected to the CoachComm X-System Player. Battery charge time should be approximately three and a half (3.5) hours.

3. Ensure the CoachComm X-System Player has been fully charged.

Note: The CoachComm X-System Player automatically powers down after approximately five (5) minutes of inactivity if it does not detect movement and is not connected to a system to conserve battery power. Shake CoachComm X-System Player for three seconds until the GREEN POWER LED comes on.

Assemble Parts

1. Attach speaker assembly. Connect the Speaker Assembly to the speaker connector on the CoachComm X-System Player. Check the Speaker Assembly is snapped into place and is securely connected to the CoachComm X-System Player.
2. Attach velcro to X-System Player, battery, and speakers. Attach the “hook” side of the velcro onto the CoachComm X-System Player module components, and attach the “loop” side of the velcro to the helmet.

Note: The rectangle velcro should be attached to the CoachComm X-System Player and battery on the non-label side. The circle velcro should be attached to the speakers on the side without speaker holes.

Determine Placement of Components



WARNING: To prevent SERIOUS INJURY or DEATH, ALWAYS contact the helmet manufacturer for the approved device placement locations for the Radio Pack and its accessories. These may vary between helmet models and between helmet manufacturers.

1. Adjust volume to lowest level. Before installing the CoachComm X-System Player and Speaker Assembly, turn the volume to its lowest level using X-Ware.



CAUTION: HEARING LOSS HAZARD. To prevent possible permanent hearing loss, ALWAYS set the volume as low as possible depending on the ambient noise at practice or at a game.

- » DO NOT use Radio Pack if it emits any unusual loud noise. Turn Radio Pack off and contact CoachComm Customer Service.
- » Permanent hearing loss may result from exposure to high volumes or other loud noises.

2. Follow the recommendations of the helmet manufacturer for the specific model helmet.

Power Off

Auto Sleep: Player module automatically goes into a sleep/low-power mode after approximately five (5) minutes of inactivity if it does not detect movement and is not connected to a system to conserve battery power.

Power Off: Unplug the CoachComm X-System Player Rechargeable Battery from the battery connector.

Note: Charge the CoachComm X-System Player battery after each use. Disconnect battery if storing for more than a week.

Product Care

To prevent damage to X-System Player Module:

- Never use cleaners that contain solvents.
- Keep liquid and foreign objects out of the device openings.
- If the product is exposed to rain or moisture, gently wipe off all surfaces, cables, and cable connections as soon as possible and allow unit to dry before storing in your case.

After each use:

- Power off all X-System Player Modules. Thoroughly dry off any moisture. Properly stow all gear in your case.
- Fully charge battery.
- Clean using a soft, damp cloth if needed.

CoachComm X-System Player Module Specifications

Specification	CoachComm X-System Player	CoachComm X-System Player Mini
Length:	1.875 in.	4.7 in. (with antenna), 1.86 in (module body)
Width:	2.75 in.	1.45 in.
Height:	0.625 in.	0.4 in.
Weight	0.25 lbs (113 g)	0.19 lbs (86 g)

X-System Referee Cutoff

As part of the CoachComm X-System Player workflow and integration, CoachComm has built in the ability to accommodate a referee cutoff or mute function. This function will mute all communication to CoachComm X-System Player modules (for both teams in a game day environment) through the use of a Referee Cutoff Switch that can be connected either wired or wireless through an existing X-System. Through the referee cutoff function, officials now have the ability to ensure that both team's player communications have been cutoff for the designated period of time. To add confidence that the CoachComm X-System Player modules are being muted, a confidence indicator light has been added that should be installed on a Radio Transceiver (RT) located on the X-System's mast. By mounting the very bright LED light on an RT, all coaches, players, and even fans will be able to see when communications to the player have been stopped.

Components

See Referee Cutoff Block Diagrams on page 124 and pages 135-137 for images of components.

- XRP-13 with a Referee Profile assigned

Note: A Referee Profile cannot be assigned to a XRP-22 and XRP-44.

- Referee Cutoff Switch (CAC-REFSW-01)
- Confidence Indicator Light Kit (Includes bulb) (CAC-CONFLITE-01)
 - » Confidence Indicator LED Bulb Kit (2 Bulbs & 2 Packs Grease) (CAC-LEDBULB-KIT)
- Cables
 - » 150-Foot Ethercon to Ethercon Cable for Use in a Wired Ref Cutoff Configuration (CAB-EE-150)
 - » 15-Foot Ethercon to 4-Pin Female XLR and Ethercon Y Cable for Ref Cutoff (CAB-EY4FE-15)
 - » 4-Foot 4-Pin Female XLR to Ethercon for Single Wireless Ref Cutoff Configuration (CAB-4FE-04)
 - » 3-Foot Dual 4-Pin Female XLR to Single 4-Pin Male XLR Y Cable for Dual Cutoff Interrupt (CAB-4FY4M-03)

Referee Radio Pack LCD

Home Operating Screen



Figure 158: Referee Radio Pack Home Operating Screen

Note: The screen will display “No Switch Connected” when there is no switch connection to the headset input.



Figure 159: Referee Radio Pack Switch Not Connected

Secondary Operating Screen

Since there is no menu on the Referee Radio Pack, holding down the Menu button will access the Secondary Operating screen.

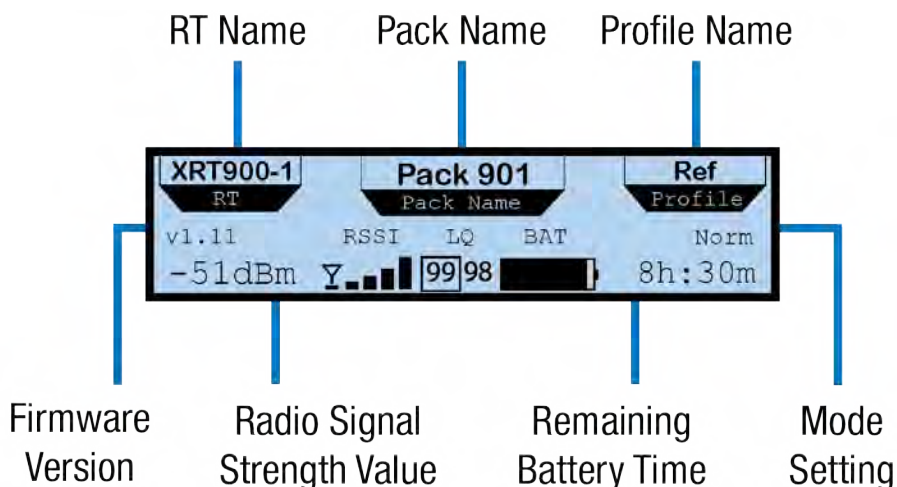

Figure 160: Referee Radio Pack Secondary Operating Screen

Adding a Referee Profile

See “Adding a Profile” on page 69 for information on how to add a profile in X-Ware. When adding the Referee profile, choose Referee Interrupt Device as the device type. See Figure 161 for an example of a Referee Profile.



Figure 161: Referee Profile Example

See “Assigning New Profiles” on page 60 for information on assigning this profile to the pack that will function as the Referee Cutoff.

Note: Referee Radio Packs cannot be unpaired from X-System through right clicking the pack in X-Ware. Unpairing must be done through the CU.

Player Communications Mute Indication

X-Ware

When coach to player communication is muted, the communication status indicator at the bottom of the screen, the player pack icon, and the referee pack icon (“Figure 75: X-Ware Referee RP Icon” on page 58) will show “Muted” on a red icon flag.

Referee Radio Pack

When coach to player communication is muted, the Referee Radio Pack will display “Player Comms MUTED” on the primary screen.



Figure 162: Coach to Player Communications Muted Icons



Figure 163: Referee Radio Pack Player Comms Muted

Operation

Trigger Referee Cutoff via the Referee Cutoff Switch or the Referee Radio Pack Function Buttons.



Figure 164: Referee Cutoff Trigger



Figure 165: Referee Radio Pack Function Buttons

In case of hardware (referee cutoff switch) failure, Referee Cutoff can be set to NORMAL or MUTED from the front panel of the CU.

1. In the Main Menu, select Tech Menu > Referee Interrupt.

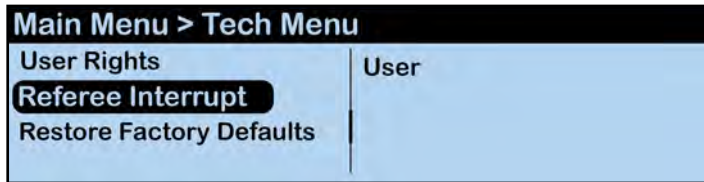

2. Set to MUTED.

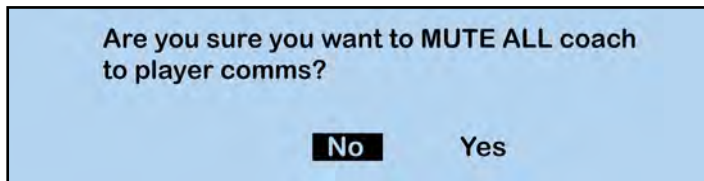

Coach to Player Cutoff Tones

By default, a series of descending and ascending tones will be sent to wireless users when Coach to Player (C2P) cutoff is engaged and disengaged. To change the volume or turn off tones from the XRP, press and hold the triangle menu button. Navigate to User Settings > C2P Tones and select High, Medium, Low, or Off. The default volume is Medium.

For wired connectivity between the field and the coach's box, to turn on the tone and/or set the volume, access the Intercom Settings in the Wired Settings of the CU as shown in the figures to the right.

Setup Notes

For wired connections, the tone is sent only to the selected hardwire ports. Mute/Unmute tones are sent to wired connections, but they will not receive "Busy" tones.

Wired connection tone settings do not get saved with the CCF, are not available in software, will stay on CU for PWR On/Off, and only reset upon factory reset or deletion of CCF.

Mute / Unmute Indication

- Descending Tones when engaged
- Ascending Tones when disengaged

Busy Tones

When the C2P function and Referee Cutoff are BOTH engaged, a busy tone of fast beeps will be heard on the wireless pack (XRP-13 only).

Who Hears the Tones?

- Wireless packs that have C2P Conferences assigned to their function button(s)
- On the field and Wireless Press Box Coaches
- Wired users who have the tones assigned to C2P Conferences (Mute / Unmute Tones Only)
- Wireless Press Box users who are using dry pair instead of fiber and have tones assigned to C2P Conferences (Mute / Unmute Tones Only)

NOTE: There are no tones if the C2P conference is assigned to a Conference/Talk button instead of a function button.

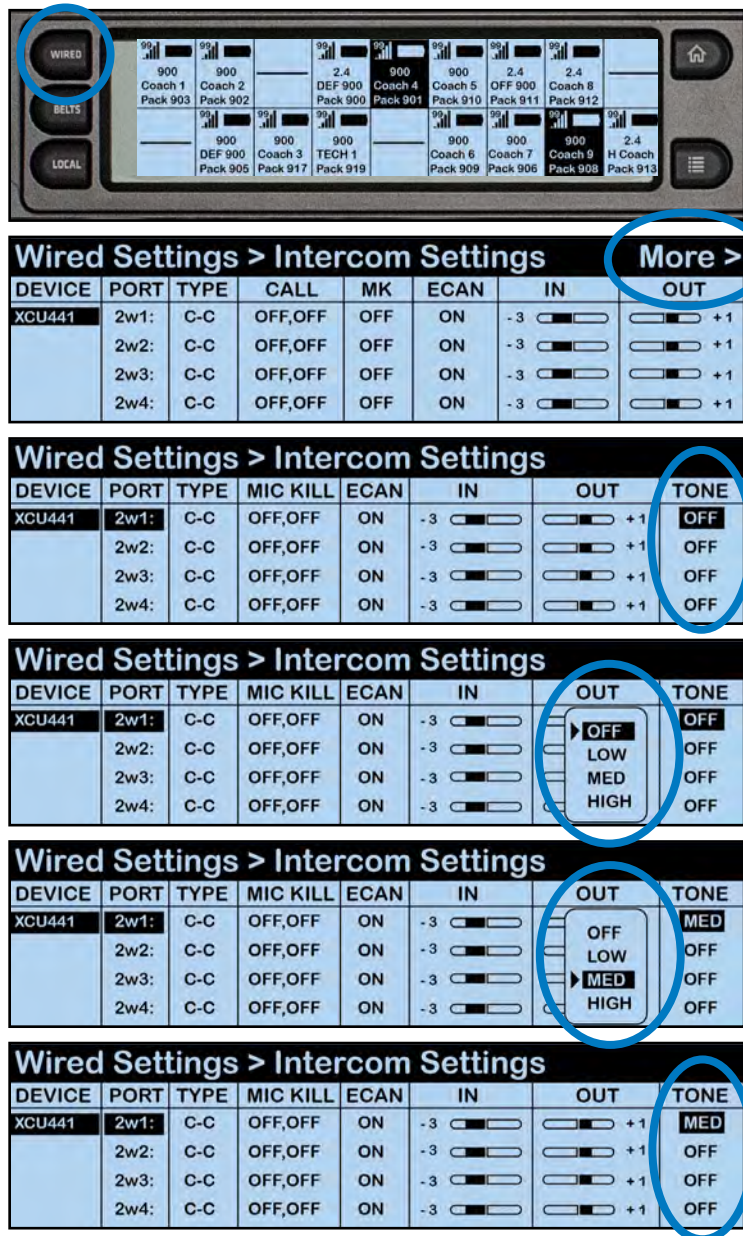

Figure 166: Change Tones in Intercom Settings on Control Unit

Referee Cutoff Cable Configuration Options

Note: Cable lengths are not to scale.

Single Wireless

See Figure 150 on page 124.

Unless two X-Systems are synced together, the Single Wireless configuration will only mute coach to player communication for one sideline's X-System (Home or Away). The other sideline X-System will require a separate Referee Cutoff cable configuration for muting player communications (Single Wireless or Wired).

Wired

Unless two X-Systems are synced together, the Wired configuration will only mute coach to player communication for one sideline's X-System (Home or Away). The other sideline X-System will require a separate Referee Cutoff cable configuration for muting player communications (Single Wireless or Wired).

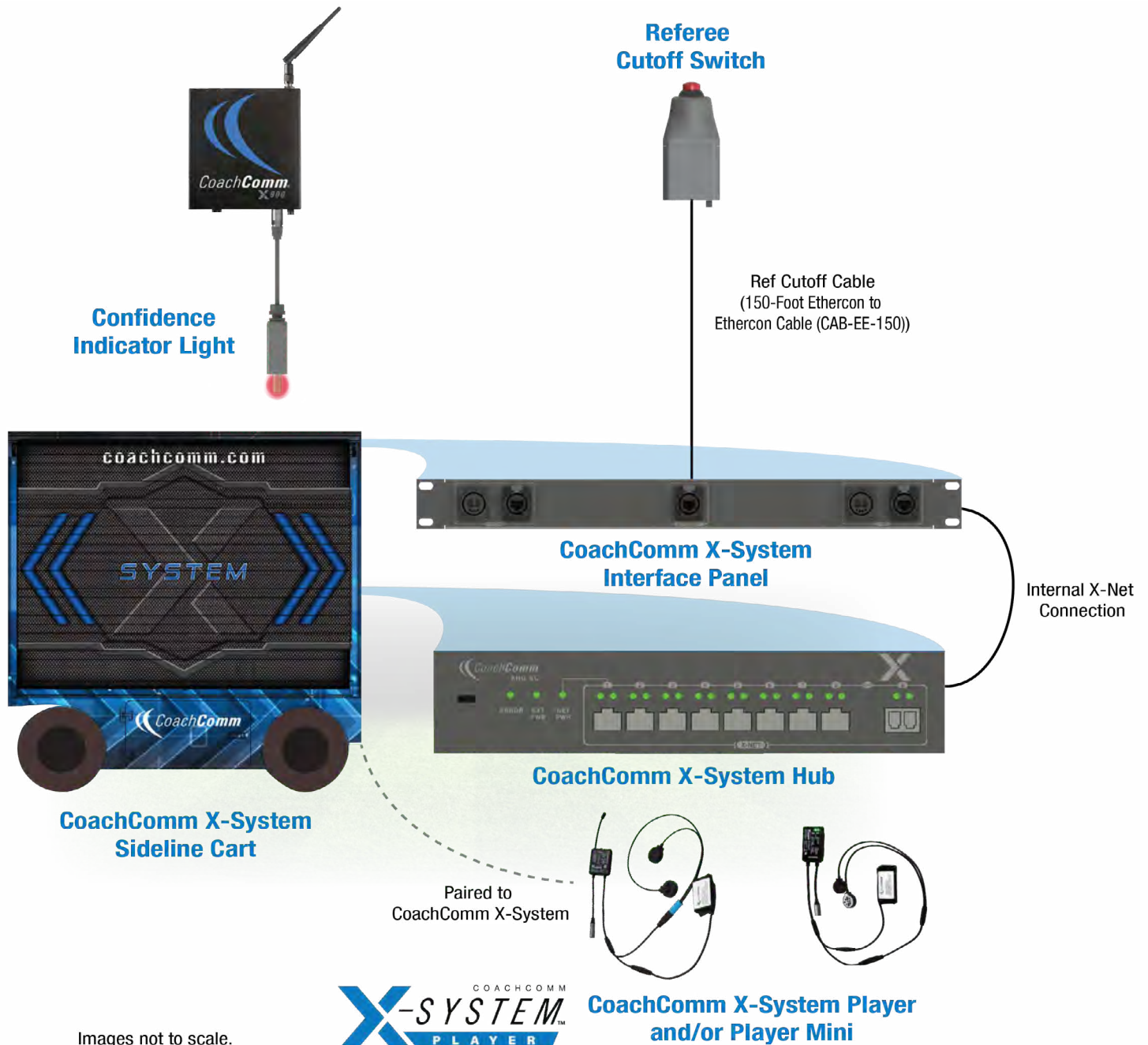

Images not to scale.



Figure 167: CoachComm X-System Player Block Diagram (Wired Referee Cutoff Configuration)

Dual Wireless

The Dual Wireless configuration will mute coach to player communication for both sidelines' X-System (Home and Away). The Referee Cutoff Switch is connected to two Referee RPs via cable; one RP is paired to each sideline's X-System.

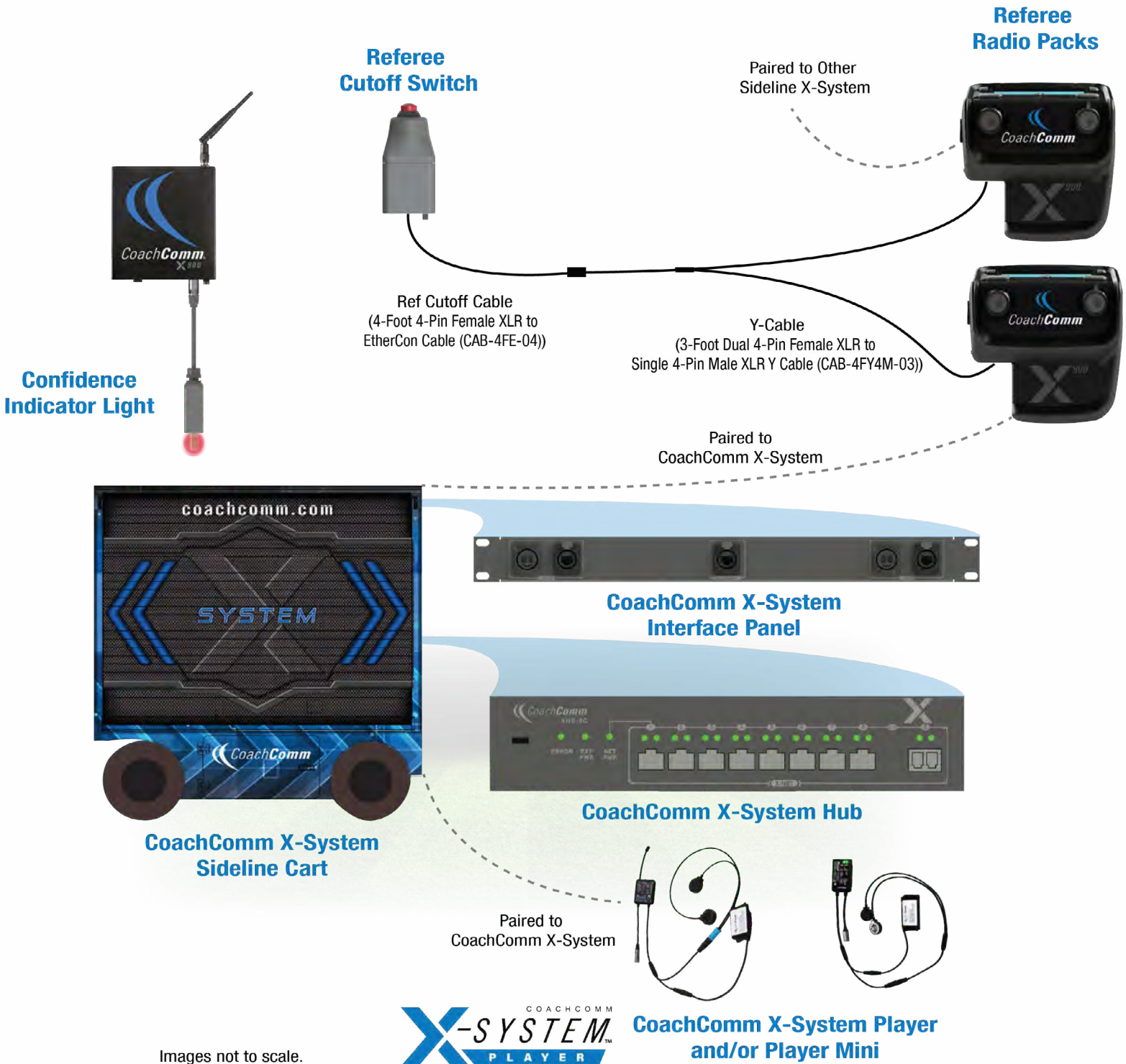

Images not to scale.

Figure 168: CoachComm X-System Player Block Diagram (Dual Wireless Referee Cutoff Configuration)

Hybrid

The Hybrid configuration will mute coach to player communication for both sidelines' X-System (Home and Away). The Referee Cutoff Switch is connected to one Referee RP and to the CoachComm X-System Player I/O Panel in the X-Cart via cable; the Referee RP should be paired to the sideline X-System that is not connected to the cutoff switch via CoachComm X-System Player I/O Panel.

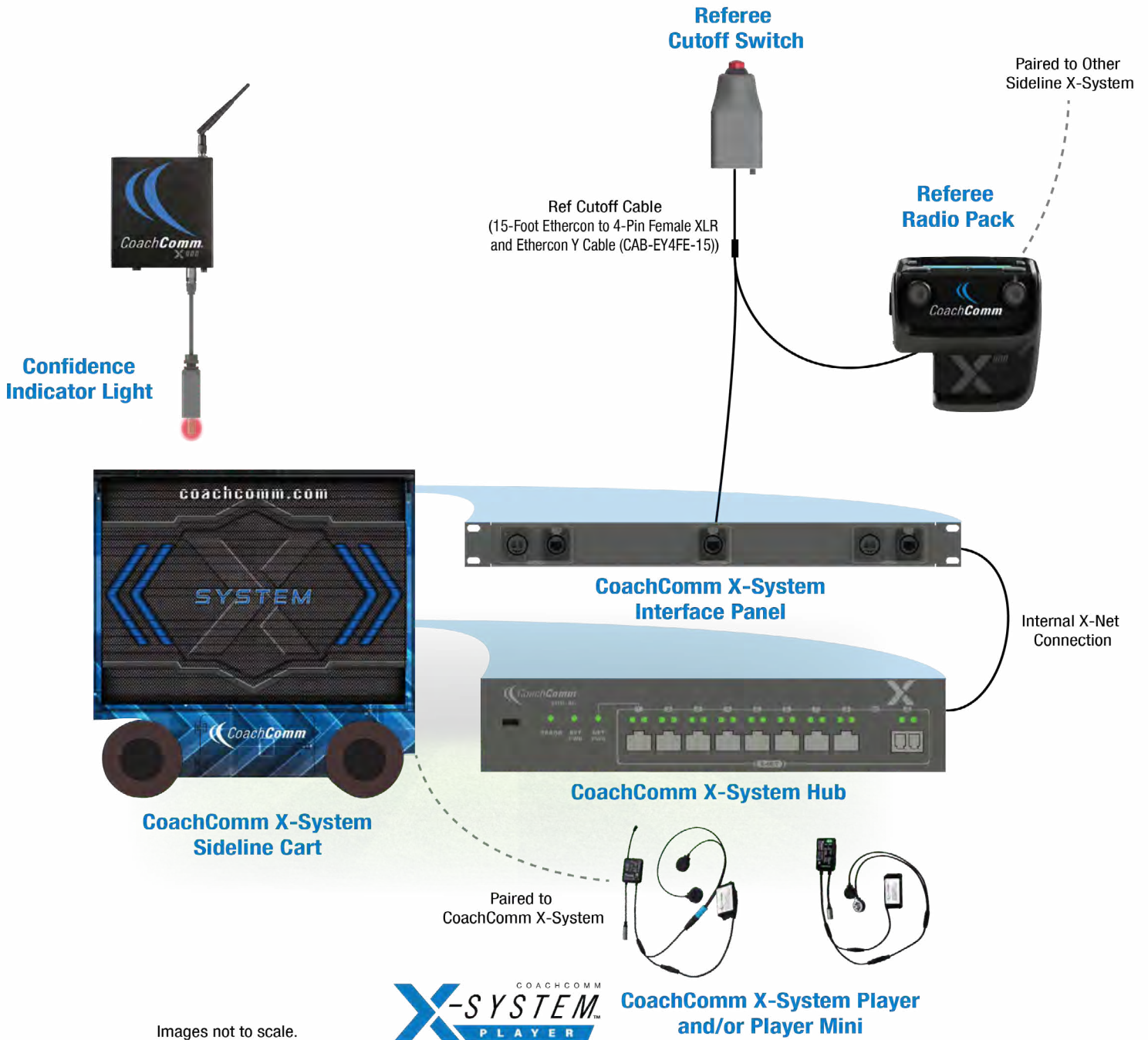

Images not to scale.

Figure 169: CoachComm X-System Player Block Diagram (Hybrid Referee Cutoff Configuration)

CoachComm to GSC Referee Cutoff Integration

1. Connect the 4-Pin Female XLR from the Extender cable (10, 30, or 100 feet) into the OUTPUT connector (4-Pin Male) of the GSC Panel.
2. Connect the 4-Pin Male XLR from the Extender cable into the 4-Pin Female XLR connector on the CoachComm In-Line Interface.
3. Connect the EtherCon connector from the CAB-4FE-04 into the CoachComm In-Line Interface.
4. Connect the 4-Pin Female XLR from the CAB-4FE-04 into an XRP-13 Radio Pack (w/Referee Profile).

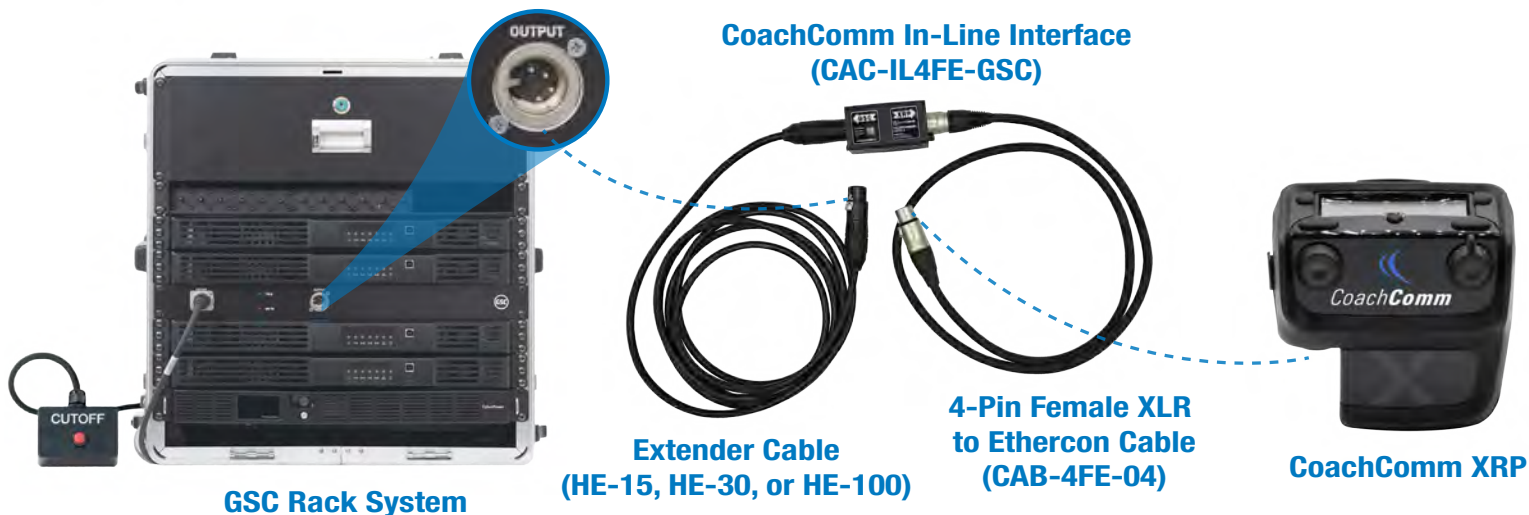

Figure 170: CoachComm to GSC Connection Diagram

Note: Separate CoachComm XRP from the GSC Rack and Antennas by at least 10 feet.

X-System HUB

The X-System Hub is only installed and used in X-Systems where the CoachComm X-System Player upgrade has been activated. The X-System hub allows expanded X-Net connectivity needed for the X-System Player upgrade integration into X-System.

Note: The hub will only be present in systems with the CoachComm X-System Player upgrade activated.

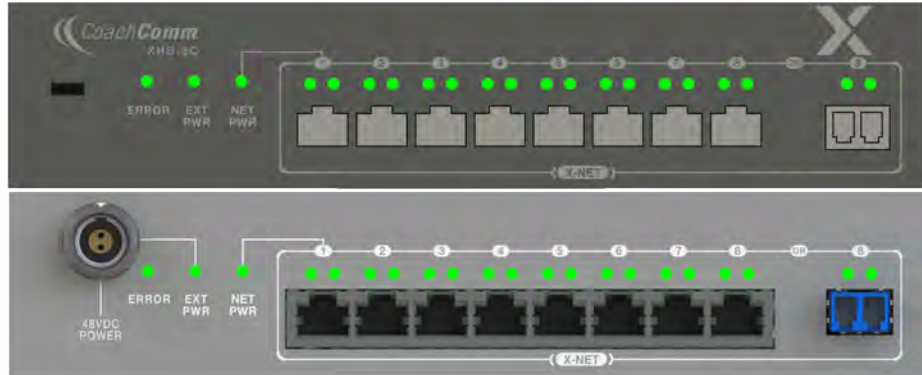

Figure 171: X-System Hub Front and Rear View

X-System Interface Panel

The X-System Interface Panel contains connections needed for CoachComm X-System Player integration with X-System. See the details below about each connection to the panel.

Note: The connections to and from the panel will not be populated in systems without the CoachComm X-System Player upgrade activated.

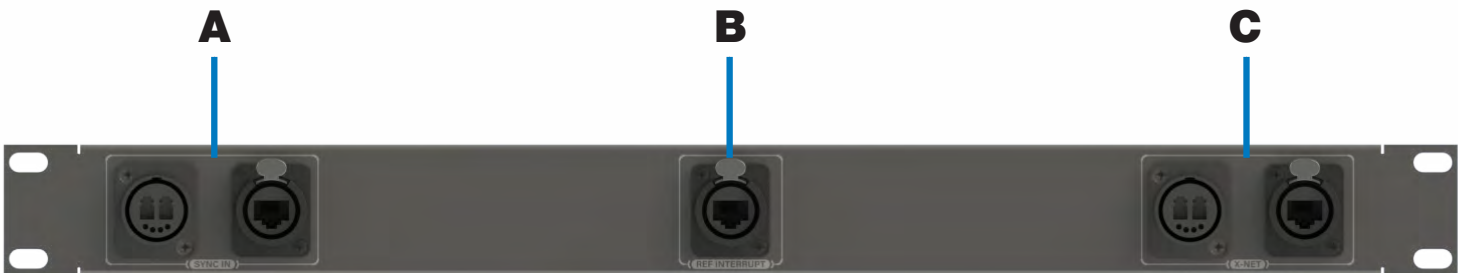

Figure 172: X-System Interface Panel Front View

- A. **Sync In:** Duplex LC Neutrik OpticalCon Duo fiber or RJ45 for syncing from another X-System's X-Net port or CrewCom system.
- B. **Ref Interrupt:** RJ45 connection for Referee Interrupt Switch.
- C. **X-Net:** Duplex LC Neutrik OpticalCon Duo fiber or RJ45 X-Net connection for connection out to another X-System or X-System device (e.g. Coach to player RT).

Coach to Player High Density RT Deployment

The coaches' communication system should be set up as usual with three RTs. The additional coach to player communication RT should be daisy chained on the mast to the RT Loop port of the 3rd RT. All RT antennas should be at a 45° angle.

Note: In some situations or difficult RF environments it may be necessary to deploy the high density RT at least 25 yards from the main mast.

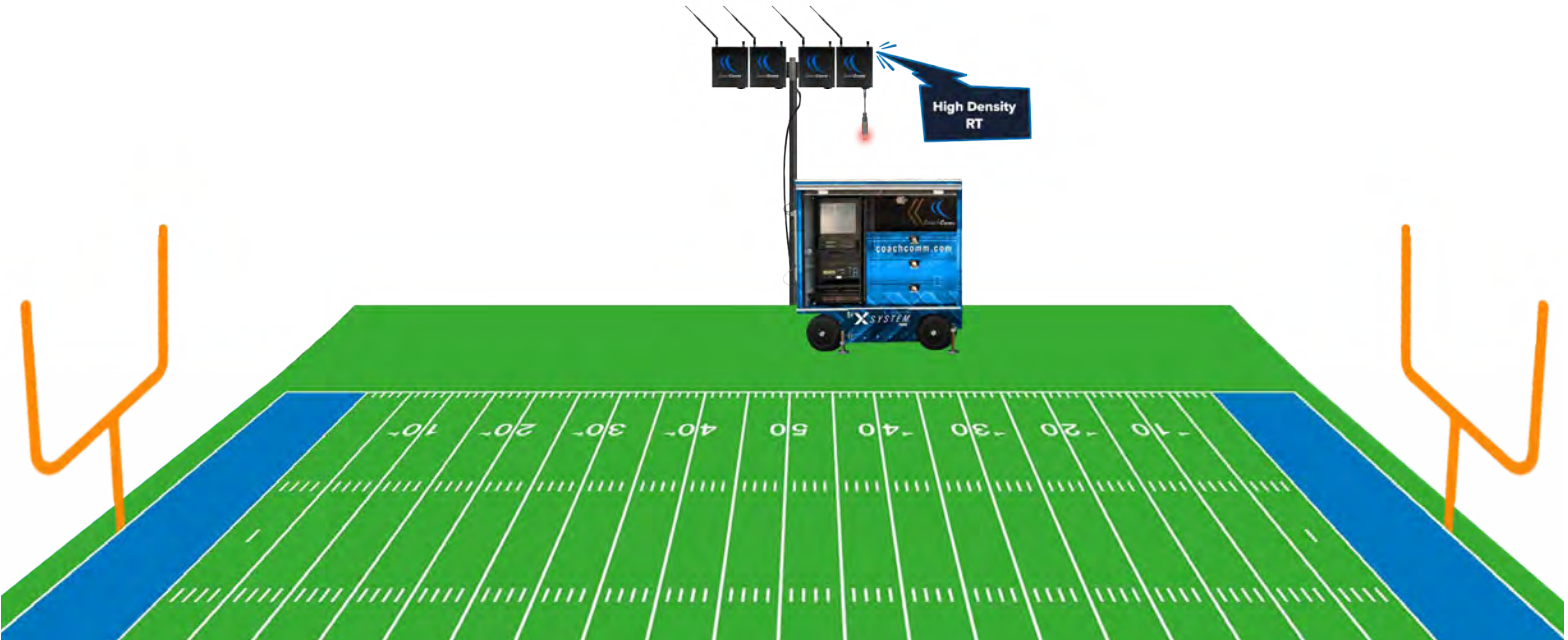

Figure 173: High Density Mode Radio Transceiver Deployment



Figure 174: RTs and Antennas on Mast

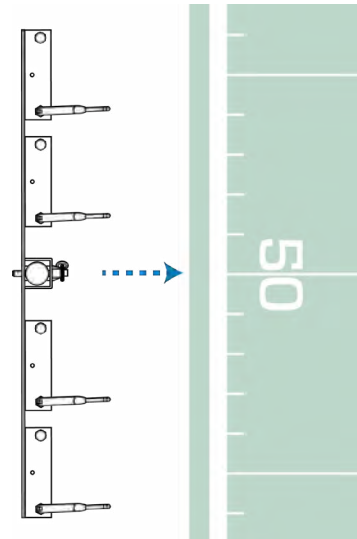

Figure 175: RTs (CoachComm Logo) Pointed Towards Opposing Team and Antennas at a 45-degree Angle

Appendix D: Standalone RT Mode

Required Equipment (Setup and Deployment)

- Control Unit (at least 1 for setup)
- Radio Packs (RPs)
- Player Receivers
- Radio Transceivers (RTs)
- RT External Power Supply or RT Battery (See “Radio Transceiver (RT) Battery and Mount” on page 143)
- CoachComm Headsets

X-Ware Setup

Note: CoachComm Support may have done the X-Ware portion of your standalone setup during maintenance or created the new CCF for you. Please contact Support for assistance.

1. Save your current CCF as a backup.
2. Add the following to your CCF:
 - B. High Density (HiDen) RT as a 4th or 5th RT in the Sideline Chain of RTs
 - C. HiDen “Practice” RP Profiles
 - D. HiDen Player Receiver Profiles
 - E. Coach to Coach (C2C) Conferences, not to exceed four total, including C2P Conferences
3. Ensure the RT, RPs, and player receivers you will use in standalone mode are set to high density mode.
4. Ensure the XRP-44/22/13 you are using with standalone mode shares a conference(s) with player receivers.
5. Ensure all devices are updated to firmware version 1.19 or above.

Note: All devices must be on the same firmware version for Standalone Mode to function properly.

CoachComm X-System Setup

1. Power on CoachComm X-System.
2. Upload the new CCF to the CU and restart it.
3. Enter Live Mode in X-Ware and verify every device is connected and powered on.
4. Pair player receivers and RPs to the CU via USB Cable.
 - A. While configuring, the RT’s Tx light will blink.
5. After waiting for the TX light of the HiDen RT to remain solid for 10 seconds, the ping LED on top of the RT will light temporarily indicating the RT is ready for standalone mode.
6. Disconnect the RT from the X-NET port of the X-System. Power the RT with an external power supply or battery.
7. The “Mode” light on the RT will continuously flash blue, indicating HiDen Standalone mode.

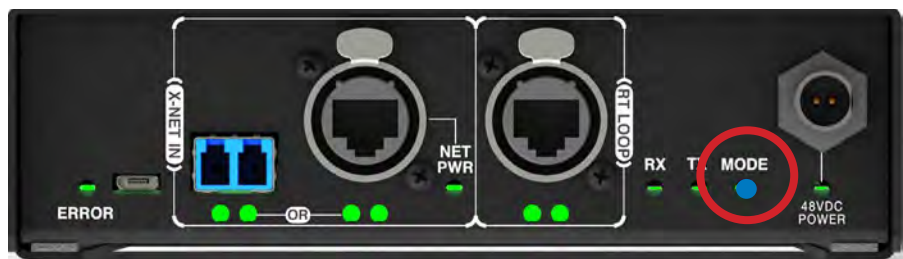

Figure 176: RT Mode Light

Standalone RT Operation Notes

- While in Standalone mode, the RP secondary screen (press triangle button) should indicate “Practice” where “RT” would typically be on the top left.

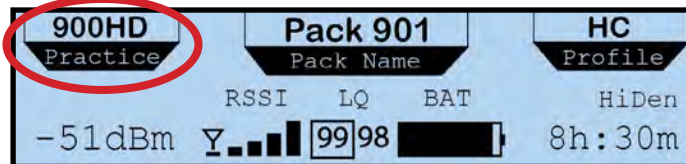

Figure 177: RP Connected to RT in Standalone Mode

- Standalone Operation Mode works the same as High Density mode: 4 available talk slots and up to 32 connected devices. See “Operational Modes” on page 75.
 - » Only four coaches will be able to have their talk buttons activated at once.
 - » All coach and player devices will be able to listen to its designated conference(s) at all times.

Player Receiver Volume Control in Standalone Mode

Since there is no X-Ware access in Standalone mode or volume control on the player receiver, the C2P conference volume can be changed from any Coach’s RP. The default player receiver volume in Standalone mode is 15.

Single Volume, 3 Conference Radio Pack (XRP-13): Function Buttons

- Activate talk (press and hold for momentary, press and release for latch) on the desired C2P conference by using the assigned function button.
- With talk active, press down the volume button and function button. This will show the current player receiver volume on that conference, differentiated by a star (*). e.g. 15*
- While simultaneously holding down the volume knob with talk active, twist the volume knob to adjust player receiver volume. This will change the volume of all player receivers on the selected conference.
- Using another RP, verify that the volume changes took effect.
 - Any RP with a C2P conference assigned to it will have the ability to adjust the player receiver’s volume.
 - Volume changes are global to the selected conference. There are no individual player module volume controls in Standalone RT Mode.
 - When returning player modules to the game day system, the original volumes from the last use with the full system will be restored.
 - Returning player modules back to the Standalone RT Mode transceiver will also restore volumes to the last used setting of that mode.

2 or 4 Volume Radio Packs (XRP-22/44): Standard Conference Buttons

- Activate talk on any conference shared with player receivers.
- Push down the volume button for that conference.
- The current volume of player receivers on that conference will be shown in the conference box with a star.
- While holding down the volume knob with talk active, twist the volume knob to adjust player receiver volume. This will change the volume of all player receivers on the selected conference.
- Press down the volume knob of the same conference on another RP to verify the change. The volume should match what you just set it to.

Note: You don’t have to have talk active to read the player receiver volume, just to change it, unless the C2P conference is associated with a momentary/latched function button.

Radio Transceiver (RT) Battery and Mount

The RT battery, mount, and bracket are sold separately:

- CBT-VMNT-MTRT or CBT-VMNT-IPRT: IndiPro V-Mount Battery Adapter Plate
- CBT-LI98-VMNT: IndiPRO Tools 98Wh Micro-Series V-Mount Li-Ion Battery and Charger
- CCAC-RTM-SMU: Single Transceiver Multi-Use Mounting Bracket

Setup

1. Make sure you have all required items for assembly (from left to right):
 - » V-Mount Battery Adapter
 - » 4 Long Mounting Screws
 - » V-Mount Battery
 - » RT Mounting Bracket
 - » 2 Short Mounting Screws
 - » CoachComm X-System Radio Transceiver (RT) or IP-Rated Radio Transceiver (IPRT)

Note: Figure examples show the metal RT. The IPRT and IPRT V-Mount Battery Adapter connector will look different from the pictures below.



2. Use the 2 Short Mounting Screws to attach the RT Mounting Bracket to the RT/IPRT. You will use the 2 short screws that come with the V-Mount Battery Adapter, not the thumb screws that come with the RT Mounting Bracket.



- Use the 4 Long Mounting Screws to attach the V-Mount Battery Adapter to the RT Mounting Bracket.



- Plug the V-Mount Battery Adapter cord into the RT/IPRT power connection.

Note: For metal RT, make sure to align the keyed female connector properly and do not force it into the RT's male connector.

- Attach a V-Mount Battery to power the RT/IPRT. Below is the completed setup (shown with adapter and stand sold separately).



Charging

Charge battery (sold separately) via the D-Tap connector on the side of the battery under the larger rubber cover or via D-Tap connector on the side of the V-Mount Battery Adapter.





CoachComm LLC
205 Technology Parkway
Auburn, Alabama 36830
1.800.749.2761
www.coachcomm.com

Copyright © 2016-2026 CoachComm LLC. All rights reserved. SmartBoom®, CoachComm X-System®, and CoachComm X-System Player™ are trademarks of CoachComm, LLC. Any and all other trademark references within this document are property of their respective owners.

Document Reference: D0000281_P